

# Salient Features

## In-circuit- and Function Test System

# ATS-MFT 770 ATS-SMFT 780

**In-circuit test:** max. 4,320 channels (not multiplex)

**Function test:** analog, digital, pulse, microprocessor, power electronic, power supply test

### Software

Menu-driven programming  
APG and autolearn  
graphical display of fault location  
integration of external programs  
Flashing, CAD-data import

### Boundary Scan

with JTAG-programmer and graphical display of fault location

### Evaluation of Displays

LCD, LED, dot matrix, mask display, seven segment



ATS-MFT 770 In-circuit-Function Test System

### Quality Management

Statistics, reference test, database connection – ODBC incl., unit for system calibration and system diagnose

### Bus Systems

Profibus, CAN-bus, GPIB/IEEE, RS232-, RS485, SPI, I<sup>2</sup>C-interface, K-bus, DeviceNet, LIN-bus, VISA-bus, Lon-bus, EIB-bus, TCP/IP ...

### Fixturing

cost effective manual and pneumatic test fixtures; software for bed-of-nails construction, semi-automatic system for fixture construction

## REINHARDT

### System- und Messelectronic GmbH

Bergstr. 33 D-86911 Diessen-Obermühlhausen

Tel. 08196 934100 und 7001 Fax 08196 7005

E-Mail: [info@reinhardt-testsystem.de](mailto:info@reinhardt-testsystem.de) <http://www.reinhardt-testsystem.de>





## Table of Contents

REINHARDT Compact-Multi Function	
Test Systems .....	5
Mechanical Data ATS-MFT 770.....	8
PC-Control.....	8
ATS-MFT 770M-1/B Basic Version.....	8
ATS-SMFT 780 Basic Version .....	8
DEC Multi-Function Board.....	9
Standard Programmable PSUs .....	9
Standard Sine and Square Wave Generator.....	9
ADM670 Measuring System In-circuit Test .....	10
ADM Measuring Unit Function .....	12
MMX670 Stimulus Matrix .....	12
MMX72 Stimulus Matrix .....	13
EMX48 Stimulus Matrix .....	13
HSM670 High Voltage Stimulus Matrix .....	13
PMX16 Power Matrix.....	13
SBus.....	14
RMX 96 Measuring Matrix .....	14
Measuring-Logic-Stimulus Matrix RML32 .....	14
VMX8 High-Voltage Measuring Matrix .....	15
ZDC100 Zener Diode Measuring Board 100V .....	15
LOG670 Logic Boards.....	15
LOG96 Logic Boards.....	16
PML670 Precision-Measuring-Logic Board.....	16
Serial Logic Data – Serial Field Bus Systems .....	16
Transient Recorder (Oscilloscope) .....	16
Resistance Decade and Motorised Trimmer (Option) .....	17
Additional Voltage Sources (Options).....	18
Additional Load (optional).....	18
AC-Voltage Source 280 VAC – 350 VDC (optional) .....	18
Expansion Power Matrix (optional).....	18
Function/Arbitrary Waveform Generator (optional).....	19
System Diagnose and Calibration Device (optional) .....	19
Interface .....	20
Universal Exchange Fixture .....	20
Ergonomic Profile Desk (optional).....	20
Profile Cabinet (optional).....	21
Extended Tasks Using Power Electronics .....	22
High Voltage Protection – Protection Module for the In-circuit-Test .....	24
High Voltage Test .....	24
HVT 16 Voltage Divider for Measuring up to 1,000V.....	24
Support Modules For Mounting into the Fixture .....	24
HFMOD High Frequency Measuring and Dividing Module 200–1,100 MHz .....	25
HFPKMOD Peak Voltage Measuring Module.....	25
OPAMOD Impedance Transformer .....	25
OPTOMOD Opto-Coupler Module .....	25
STROMMOD Current Measuring Module .....	25
DACMOD Current and Voltage Supplier Module .....	25
GenMOD Sine and Square Wave Module .....	26
HFGenMOD HF-Square Wave Module .....	26
PGENMOD Pulse Generator Module.....	26
RelMOD Relay Module.....	26
HVRelMOD High Voltage Relay Module .....	26

AdapLMXModule .....	26
MicMod Microphone Module .....	27
FARB-LED-Module .....	27
16FARBMod Module .....	27
TempMOD Temperature and Humidity Measuring Module .....	27
Spring-suspended Switch Contact Pin .....	27
Pneumatic Contact Pin .....	28
Programmer-Connector Module ProgMOD16 .....	28
Electronic Actuator M12 .....	28
SteuerMod-Inline USB-Module .....	28
Start Stop Steuerung USB-Module .....	28
TrigMessMod .....	29
ADAEEP Fixture Recognition Module .....	29
Circle Marker .....	29
DUT_LED Module Optical Display of Status .....	29
BEE-Module – Recognition if a Board is Placed or Removed .....	29
Measuring Ranges .....	30
In-circuit Test .....	30
Function Test .....	37
Software .....	49
Test Program Wizard .....	49
Test Sequence .....	50
Creating a Fixture and a Test Program .....	52
Programming the Test System and Working with Gerber Files .....	53
In-circuit Test and its Programming .....	54
Assigning Tracks .....	54
Pin Contact Test Editor .....	55
Track and Insulation Test Editor .....	55
IC-Test-Editor .....	55
Programming an IC-Open Test .....	56
Programming a Components Test .....	56
Programming a Components Test Manually .....	56
2. Semi-automatic Programming .....	58
3. Using CAD-data .....	59
Test Run .....	59
Special Functions and Branch Out .....	59
Multiple Printed Panels .....	60
Function Test Editor .....	61
Fieldbusses .....	64
Integrating External Programs .....	64
Fault Journal .....	65
Quality Management – Reference Test .....	65
Program Generators for Function Test .....	65
Modification Listing .....	66
Statistical Calculations on Faults and Parameters .....	66
Open Database Connectivity – ODBC-Interface (Option) .....	66
Downloading FPGAs or Software .....	67
ODT Optical Display Test (Option) .....	67
Display of Fault Location .....	67
Boundary Scan .....	68
RST 40 REINHARDT-Synchro-Test .....	69
Programming Station .....	69
RDR Repair Station .....	69
REINHARDT ASCII-Interface .....	70
Transfer of Bills of Materials for Creating Test Programs for the REINHARDT-In-circuit Test .....	71

OLR-Software – Optical Layout-Reconstruction for Creating a Test Program and a Fixture .....	71
Our Complete Solution incl. Fixturing .....	73
Various solutions for building test fixtures semi-automatically by using Gerber files .....	73
Elaborating Gerber Files .....	74
Building Fixtures .....	74
Test Fixtures .....	75
Our Fixturing System .....	76
Bed of nails .....	76
Retention box .....	77
Working method of an exchange plate fixture .....	77
Contacting from top and bottom .....	77
Our Fixtures .....	78
Type 40 Pneumatic Fixture makes contact from both sides .....	78
Type 42 Manual Fixture allows double-sided contacting .....	78
Type 42C Manual Fixture .....	78
Type 82C Manual Fixture .....	79
Type 82B Manual Fixture .....	79
Type 127 Manual Fixture .....	79
Type 147 Manual Fixture .....	80
Type UJ20 Universally Adjustable Test Fixture .....	80
Tandem Module .....	81
Universal Interface Box 165 .....	81
Converter- and Ranging Box .....	81
In-line-System .....	81
Survey Fixture Types .....	83
Block Diagram ATS-MFT 770M-1/B .....	85
Block Diagram ATS-SMFT 780 .....	86



<b>REINHARDT Compact-Multi Function Test Systems</b>	<b>MFT 770M-1/B</b> 	<b>SMFT 780</b> 	<b>UKMFT 727*</b> 	<b>UKMFT 627 *</b> 	<b>UKMFT 616 *</b> 
<b>HARDWARE</b>					
<b>Measuring unit in-circuit test ADM</b>	●	●	●	●	●
<b>Measuring unit Function test ADM</b>	●	●	●	●	●
<b>Operating system</b>	WIN 11®	WIN 11®	WIN 11®	WIN 11®	WIN 11®
<b>PC Monitor Keyboard Mouse</b>	●	●	○	○	○
<b>Free board positions after basic configuration</b>	13	23	5	5	2
<b>Expansion rack</b>	○/2	○/2	–	–	–
<b>DC-sources programmable</b>	4	4	4	2	2
<b>Fixed voltages</b>	6	6	5	4	4
<b>Generator sine-square wave</b>	● 0 to 500kHz	● 0 to 500kHz	● 0 to 1 MHz	● 0 to 78kHz	● 0 to 78kHz
<b>Electronic load programmable up to 5.12A</b>	●	●	–	–	–
<b>Zener diode measuring board ZDC100 1/5/10 mA, 50/75/100 V</b>	○	○	–	–	–
<b>Measuring-logic-stimulus matrix RML</b> 32 Measuring, 24 stimulus, 32 logic channels	○ max. 256/192/256	○ max. 256/192/256	● 32 max. 224/176/224	● 32 max. 224/176/224	● 32 max. 96/72/96
<b>Measuring matrix board RMX96</b> 96 Measuring matrix channels per board, Reed relays	● 96 max. 1,440/4,320	● 480 max. 2,400/3,840	● 128 max. 608	● 128 max. 608	○ 32 max. 224
<b>High voltage measuring matrix board VMX8</b> 8 channels per board, buffer amplifier	○ 8 max. 32	● 8 max. 32	–	–	–
<b>Stimulus matrix MMX670 with PSU / MUX8</b> per board 48 channels in 12 groups of 4/ optional with PSU	● 48/– max. 384	● 48/– max. 384/552	○ / ● 8 channels max. 96	○ / ● 8 channels max. 96	○ / ● 8 channels max. 96
<b>Stimulus matrix MMX72</b> per board 72 channels in 18 groups of 4	○ 72/– max. 552	○ 72/– max. 552	○ / ● 8 channels max. 144	○ / ● 8 channels max. 144	○ / ● 8 channels max. 144
<b>Stimulus matrix EMX48</b> 48 channels per board	○ 48/– max. 384	○ 48/– max. 384	○ / ● 8 channels max. 192	○ / ● 8 channels max. 192	○ / ● 8 channels max. 96
<b>High voltage stimulus matrix HSM670, 16 channels</b> DC max. 250 V, max. 10 A, max. 300 W, AC max. 250 V, max. 10 A, max. 2,500 VA	○ max. 64 channels	○ max. 64 channels	–	–	–
<b>Power matrix PMX16 16 channels</b> DC max. 100 V, max 1,000 W	○ max. 64 channels	● 16 max. 64 channels	–	–	–
<b>Logic board bi-directional LOG670</b> 32 channels 0–30 V prog. 10 mV step	○ max. 256	● 32 max. 256	○ max. 32 23 V	○ max. 32 23 V	○ max. 32 23 V
<b>Logic board LOG96</b> 96 channels, 3.3V/5V	○ max. 256	○ max. 256	○ max. 224	○ max. 224	○ max. 128
<b>Precision measuring logic board PML</b> 16 Logic-, 16 Precision measuring channels, 16Chn. Precision PSU	○ max. 128	○ max. 128	○ max. 32	○ max. 32	○ max. 32
<b>Transient recorder TRA670, 50 MHz</b> 8 HF-inputs; 9 NF-inputs; one channel	○	●	○	○	○
<b>DC-source 3fold NGS470/670, 0 to 8 V,</b> 4A, 0 to 38 V 1 A and 0 to 38 V 1 A	○	○	–	–	–
<b>Twin PSU potential-free ENG–60V</b>	○	○	–	–	–
<b>ZNG potential-free PSU 0–25 V, resolution 0.5 mV, max. 1 A,</b> resolution 40 µA	○	○	–	–	–
<b>AC–DC-source AC670, 0 to 280 VAC max. 42W,</b> 25 Hz to 6.5 kHz in 0.1 Hz steps; DC–source 0–350VDC, 35 W	○	○	–	–	–
<b>DC-load 4fold LA470 0 to 4A, max 50V</b>	○	○	–	–	–
<b>Motorised trimmer MOT470/670 and prog.</b> resistance decade 0 to 16.777 MΩ	○ max. 2	○ max. 2	○ max. 1	○ max. 1	○ max. 1
<b>Current and sources monitor I-MON</b>	integrated	integrated	integrated	–	–
<b>Power matrix LMX670, 8 power matrix</b> incl. 8 high voltage measuring channels	○ max. 32 channels	○ max. 32 channels	–	–	–
<b>Power sources and loads POMO80, 19" 2HU</b>	○	○	○	○	○
<b>Fixture control 3 relays</b>	●	●	●	●	●
<b>Inline control 8 bit</b>	●	●	●	●	●
<b>SteuerMod USB</b>	○	○	○	●	○
<b>Bus I<sup>2</sup>C-1, COM, USB</b> RS232/422/485, I <sup>2</sup> C-2, SPI, pulse generator	● ● ●	● ● ●	● ● ●	● – –	● – –
<b>CAN-Bus, K, LIN-Bus, IEC-Bus, Lon-Bus, EIB-Bus ...</b>	○	○	○	○	○
<b>Boundary Scan fully graphical</b>	○	○	○	○	○
<b>Calibration and system diagnose</b>	○	○	○	○	○
<b>Working desk / cabinet</b>	○	●	○	○	○
<b>Test fixture</b>	○	●	○	○	○

<b>REINHARDT Compact-Multi Function Test Systems</b>	 MFT 770M-1/B	 SMFT 780	 UKMFT 727*	 UKMFT 627 *	 UKMFT 616 *
<b>SOFTWARE</b>					
<b>FOR PROGRAMMING</b>					
Live Online Editor	●	●	●	●	●
Program generator	●	●	●	●	●
WIZARD for test programs	●	●	●	●	●
Autolearn In-circuit test	●	●	●	●	●
Autolearn Function test	●	●	●	●	●
Automatic generation of the pin contact test	●	●	●	●	●
Automatic generation of the short-circuit and interrupt test	●	●	●	●	●
Automatic generation of the solder defect test	○	●	○	○	○
Autodelay	●	●	●	●	●
Autodischarge	●	●	●	●	●
Automatic generation of envelope curves	●	●	●	●	●
WIZARD DC/DC- and AC/DC-Module	●	●	●	●	●
CAD-Data interface ASCII	●	●	●	●	●
Transfer of Bills of Material BOMs	●	●	●	●	●
Universal Data Converter RUDC10	○	●	○	○	○
Eagle Interface	○	●	○	○	○
Layout reconstruction software OLR	○	○	○	○	○
Offline programming station – software	○	○	○	○	○
<b>FUNCTIONALITIES</b>					
Display of fault location and software for processing Gerber files	●	●	○	○	○
Software IC-Open and Polarity (requires ATSGERB)	○	●	○	○	○
Test of multiple printed panels	●	●	●	●	●
Ramp function	●	●	●	●	●
Handling of serial numbers	●	●	●	●	●
Communication interface	●	●	●	●	●
Various fieldbus systems, partly with optional hardware	○	○	○	○	○
Boundary Scan	○	○	○	○	○
ODT Optical display test	○	○	○	○	○
<b>FOR QUALITY MANAGEMENT</b>					
Quality management tools	●	●	●	●	●
Reference test	●	●	●	●	●
Binning	○	○	○	○	○
Relay test	●	●	●	●	●
Auto-calibration	●	●	●	●	●
Statistics software with with histogram, fault distribution	●	●	●	●	●
Live Screen statistics	●	●	●	●	●
ODBC Data base interface	○	○	○	○	○
Test program modification listing	●	●	●	●	●
<b>GENERAL</b>					
Tester and developer mode	●	●	●	●	●
Unicode-capable for worldwide operation (language)	●	●	●	●	●
Networkable	●	●	●	●	●
Offline repair station – software	○	○	○	○	○
Remote servicing/remote maintenance	●	●	●	●	●

Legend: ● : Standard, ○: Option, – : not possible

\* If you need more information about ATS-UKMFT 616, ATS-UKMFT 627 or ATS-UKMFT 727, please ask for separate brochures and salient features.



*ATS-MFT 770 Test System*

Since 1979, REINHARDT have been developing automatic test systems for electronic components such as e.g. devices used for EOL-test or modules such as a board/PCB which are tested in a function test or in an in-circuit test. An automatic test system like ATS-MFT 770 replaces test structures/devices which may be made up of boxes with e.g. turn keys and maybe with measuring modules plugged into a PC and controlled by a computer via GPIB/IEC-interface. Such a test structure is always unique, dependent on its developer and very much limited in its test capabilities.

REINHARDT-test systems hold the experiences of Peter Reinhardt, founder and owner, who has developed test systems for more than 4 decades and has made thousands of project solutions. REINHARDT acts on the maxim „Test systems by practical persons for practical persons“ and „You need not reinvent the wheel“.

The REINHARDT ATS-OS-software is operated under WINDOWS® and for a very long time it has worked

with menu-driven online-programming. This makes programming easy, practice-oriented and fast. The rest of the test program is based on this reaction and the knowledge gained. The existing test step is duplicated and the expansions are filled in.

The combined In-circuit- and Function test grants highest security for the PCB-function.

Graphic display of fault location ensures that less qualified staff can operate the unit when short-circuits, interrupts, missing components or component faults are located and displayed on screen, are located fast and exactly.

This simple and practice-oriented conception combined with modern hardware-technology allow an extremely compact construction. High switching speeds at low current consumption grant lowest heat development and therefore longevity.

## Mechanical Data ATS-MFT 770

ATS-MFT 770 is housed in a rack for use as a bench-top unit or in a 19" cabinet, but at an time it can be integrated into a production line. The test system is made up of plug-in boards with extended Euro size. The connectors to the test fixture are mounted on the plug-in boards. This means that the connection to the test fixture is only 1 cm long and that only low capacity is loaded on the signals. The backplane contains the fixed voltage supplies, the power amplifiers for the fixed and variable PSUs, generators and the electronic load. Dimensions of the ATS-MFT 770-rack: 19" wide, 470mm deep, about 200mm high

## PC-Control

Basic version ATS-MFT 770: a PC common in the trade with LCD-monitor, network connection

The PC includes an USB-interface for data communication with the test system. Free positions in the computer can be taken by one or more optional field bus boards.



## ATS-MFT 770M-1/B Basic Version

**ATS-MFT 770B Standard Equipment:** QSP13 (Sources, signals, power), programmable power supply, multi-function board, fixed voltage supply, sine and square wave generator, electronic DC-voltage load, current monitoring, in-circuit- and function measuring unit, 1 measuring matrix boards with 96 channels, 1 stimulus matrix with 48 channels, 6 programmable PSUs, and 13 free positions for expanding the system. Comprehensive software package  
Weight: ca. 22 kg

## ATS-SMFT 780 Basic Version

**ATS-SMFT 780 Standard Equipment:** QSP13 (Sources, signals, power), programmable power supply, multi-function board, fixed voltage supply, sine and square wave generator, electronic DC-voltage load, current monitoring, in-circuit- and function measuring unit, 480 measuring matrix channels (=5 measuring matrix boards with 96 channels each), 1 stimulus matrix with 48 channels, 6 programmable PSUs, 1 logic board with 32 logic channels, 8 high voltage measuring channels, 16 power matrix channels, 1 transient recorder, 23 free positions for expanding the system, USB2-interface, Start/ Stop-module, profile cabinet, test fixture type 42C.  
Weight: ca. 120 kg

## DEC Multi-Function Board

The multi-function board holds many functions: There are three power relays for fixture control as well as a 16 bit control byte (1.8 V to 5V, ca. 5 kHz) for external tasks such as e.g. automatic board feed units. On this board there are also two **I<sup>2</sup>C-Bus-controllers** (56 kHz to 1 MHz) which control the hardware for the SMD IC-solder defect test and for the auxiliary modules in the fixture. Needless to say, it can be programmed comfortably for I<sup>2</sup>C-uses of the customer. The multi-function board has a **USB2**-interface, an **SPI**-interface with 2.5 kHz to 10 MHz, level can be programmed from 1.8 V to 5 V, a pulse generator **PWM** from 0.6 Hz to 10 MHz, pulse width 50 ns to 0.8 s, 1.8 V to 5 V, two **RS232**-interfaces or one **RS422/485**-interface, 300 Hz to 1.25 MHz, a start-/stop-test system control and a test fixture identification. The multi-function board controls digital signals bi-directionally between control computer and multi-function board. The PC supplies the digital signals via an USB2-interface. The multi-function board generates the required select and control addresses for the other modules.

## Standard Programmable PSUs

In its basic version, ATS-MFT 770 holds six programmable PSUs, two of them for 0 V to +38 V, max. 2 A, another two 0 V to +38 V, max. 500 mA, for negative PSUs 0 V to -38 V at max. 1 A. A potential-free electronic load creates up to 5.12 A max. current with 100  $\mu$ A resolution. It can be used for voltages up to 90 V. In the frequency range 10 Hz to 10 kHz the load can also be modulated. The pulse duty factor can be set from 5–95 %, the resolution varies depending on the range. The basic current of the modulation can be set in the complete current range of the load.

## Standard Sine and Square Wave Generator

The sine and square wave generator of ATS-MFT 770 supplies devices under test and can be programmed in the range of 0 Hz to 1 MHz (3 db limit, 500 kHz). Maximum voltage is 25 V<sub>eff</sub> (sine) and 0–25 V<sub>pk</sub> (square wave) and 10–95 % pulse duty factor, maximum current is 1 A. Current limitation can be programmed for both sine and square wave generator. Offset voltage can be programmed with 10 mV resolution.

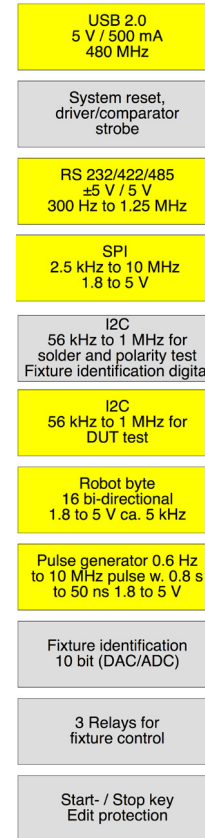

Multifunction board

Generator		Last 1	
Gen	Ein	La1	Ein
Signal	Rechteck	U[V]	12 V
F[Hz]	439,01 kHz	I[A]	4,55 A
U[V]	15 Vpk	Mon.	Aus
Mon.	Aus	Text	
Text		mit QSP13	
I[A]	750 mA	OVP:	13 V
Offs.	4,5 V	Mod.	Ein
Tastv.	10 %	F[Hz]:	1,57 kHz
		Tast.:	75 %
		Basis I:	1 A



## ADM670 Measuring System In-circuit Test

The combined In-circuit and Function measuring system measures all tasks in the In-circuit test range:

The *pin contact test* is very important and tests if e.g. a spring-suspended contact pin makes contact with the DUT before the test itself starts.

These measurements are resistive (<math><30\text{ M}\Omega</math>) or if necessary capacitive too. Program generation by autolearn in a few seconds.

The *net test* finds e.g. conductor breaks, the *isolation test* discerns if there is a solder short between nets (tracks). Continuity is defined as the resistance between two pins being less than e.g.  $5\ \Omega$  (programmable from  $5\ \Omega$ – $5\text{ k}\Omega$ ). Program generation by autolearn in a few seconds.

*Resistance measurement*, two or four terminal, uses a DC arrangement for measuring resistors of  $100\text{ m}\Omega$  to  $40\text{ M}\Omega$  in test times from 3.6 ms. The test time depends on the required measuring accuracy as well as the number of averaging per test step. Program generation automatic (CAD-data required) or manual.

For measuring components in parallel connections you can include up to 8 dynamic guards, which compensate the potentials with ca. 200 mA max. current so that the component can be measured correctly. Guarding is programmed by Autoguard or manual entry.

*Capacitances* of only a few pF up to 50 mF are measured with high resolutions. With the help of an autocalibration, the basic capacitances are nulled and even small capacitance below 50 pF can be measured with sufficient accuracy. The required frequency is selected by software dependent on the respective measured value.

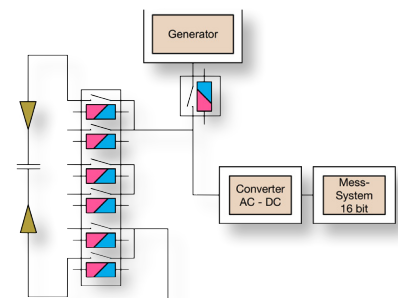
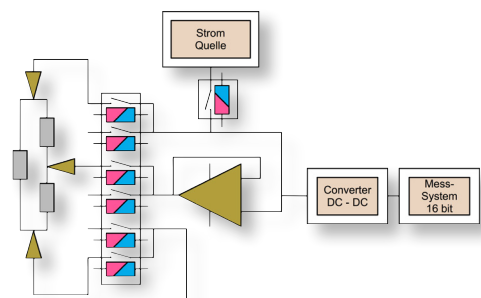
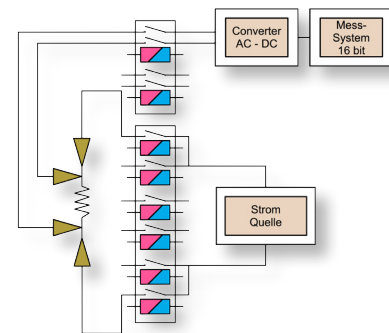
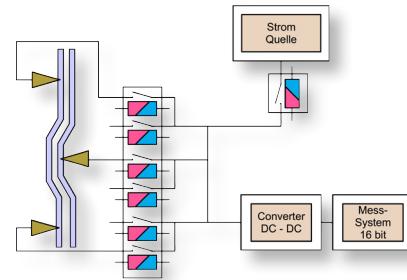
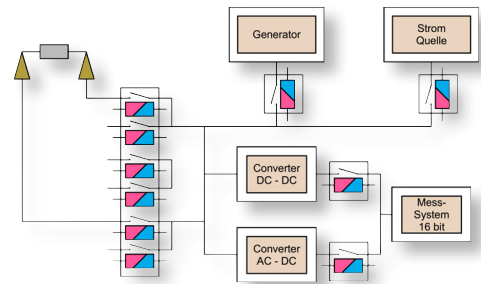

*Electrolytic capacitors* are also measured.

*Inductances* can be measured from a few  $\mu\text{H}$  to 2H. We use an extremely constant symmetrical sine signal with a peak to peak voltage of 400mV. A series resistance is used to apply one of those sine wave signals to the coil to be tested. The test system automatically selects the measuring frequency.

*Diodes and zener diodes* are measured up to voltages of 28 V. Several currents can be pre-selected.

Especially with power supply units, there may be circuit constellations, such as coil and resistor and capacitors in parallel which cannot be in-circuit tested with common measuring methods. Such connections are measured with the *impedance measurement*. It is based on the same measuring method as is L-measurement, only difference is that the series resistor and the measuring frequency can be chosen as you want.

In *transistor measurement*, the transistor is turned on with a DC-voltage at the base. The collector-emitter voltage is measured and evaluated. The base and collector signal can be programmed in voltage and in current.

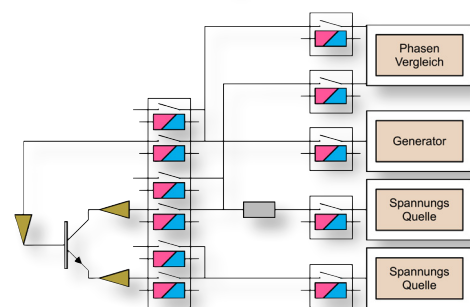
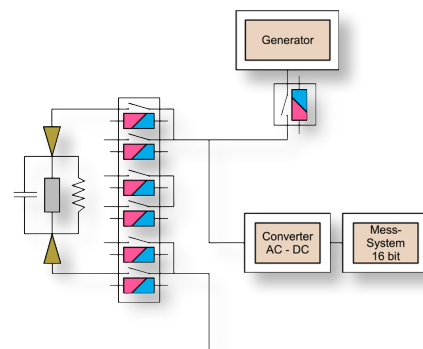
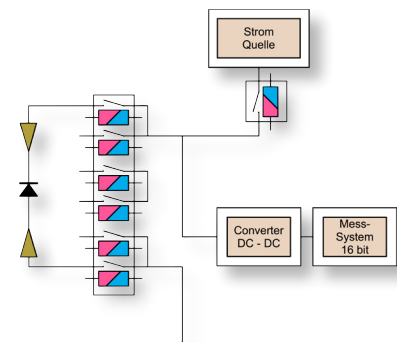
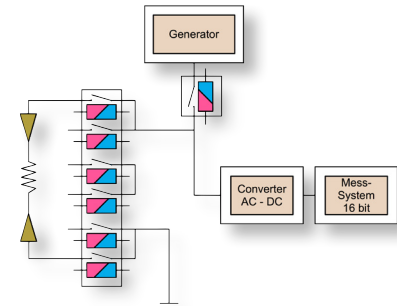
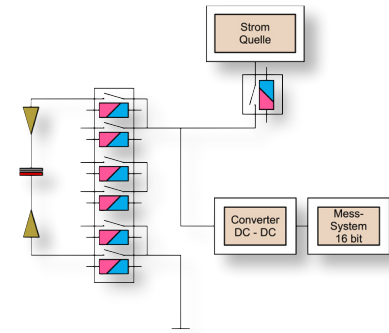

These types of transistors can be measured with the *transistor measurement*: NPN, PNP, P-channel MOSFET, N-channel MOSFET and J-FET transistors.

When an *operational amplifier* is tested, PSU1 supplies the voltage which is applied via an MMX-channel. In this test, the operational amplifier operates as buffer. A DC-voltage is applied at the non-inverting input of the operational amplifier. The output voltage of the operational amplifier is measured and evaluated.

### ADM Measuring Unit Function

Our measuring system function test and that for the in-circuit test are on the same board. Voltages are measured in 7 ranges from the lower mV range up to 100 V at 16 bit resolution. Basic accuracy is 0.05 %. AC voltages are measured as true RMS value from 45 Hz to 300 kHz. Peak voltage is measured up to 75 kHz.

Current is measured via external shunts which are built into the fixture. The time and frequency measuring unit on the measuring unit is for pulse and signal ranges. Two programmable comparators are used for setting the switching level for the signal voltages from -30V to +30V. Measuring ranges are: frequency, periods, pulse widths, rise and fall times, event counting, pulse ratios, phase shift, delay times between two channels with a resolution of better than 50 ns.

The TRA ADM-measurement records analogue signals up to a sample width of 10  $\mu$ s and displays them graphically. The time base can be pre-set. You can trigger both internally and externally. The signal recorded in this way, be it sine or any pulse form, can be evaluated fully automatically with envelope curves. For evaluation, there are of course separate measurements such as peak to peak, peak, rise time, fall time, pulse widths and frequency or periods. There is a Fourier analysis as well as a measurement of the distortion factor.

### MMX670 Stimulus Matrix

The MMX670 stimulus matrix is used e. g. for engaging and switching stimulus tasks. Its application is identical with that of its predecessor SMX670. It holds 48 relays which are designed for 2 A switching current. The MMX670-board is compatible with the SMX670, but is more flexible, since the High- and the Low-branch of each channel is no longer switched in parallel, but the High and the Low branch can be programmed individually.

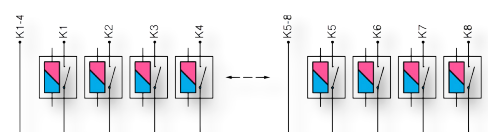
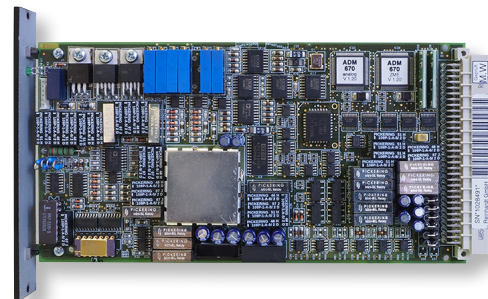
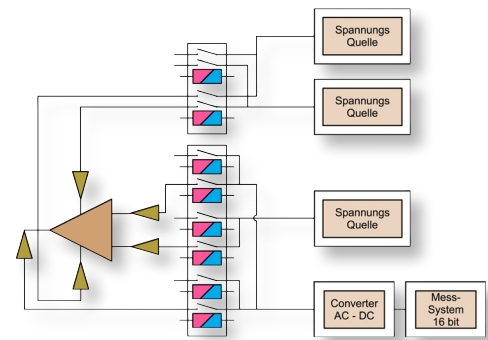
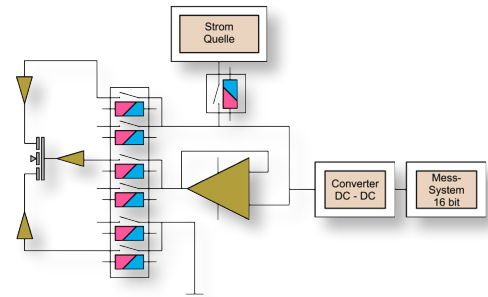



There are 48 stimulus channels (one-wire technique) for potential-free stimulation and measurement in a total of 12 groups with 4 in- and outputs each.

Two 16Bit-PSUs, 0 to +38 V, max. 500 mA, can be programmed in 1 mV-steps. Current can be programmed in 10  $\mu$ A-steps from 30–500 mA. PSU2 can also be coded from 0 V to -38 V.

ATS-MFT 770: Standard

ATS-SMFT 780: Standard

Maximum expansion: 8 boards (=384 stimulus channels)

### MMX72 Stimulus Matrix

The stimulus channels of the MMX72 stimulus matrix have the same structure as those of the MMX 670. There are 72 stimulus channels (one-wire technique) for potentialfree stimulation and measurement in a total of 18 groups with 4 in- and outputs each.

ATS-MFT 770: Option

ATS-SMFT 780: Option

Maximum expansion: 8 boards (=552 stimulus channels)

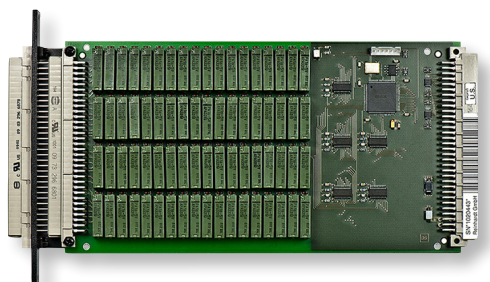

### EMX48 Stimulus Matrix

The EMX48 stimulus matrix too is used e. g. for engaging and switching stimulus tasks. It holds 48 power relays with max. 90 W switching power, max. 2 A switching current.

There are 48 stimulus channels (one-wire technique) for potentialfree stimulation and measurement.

ATS-MFT 770: Option

ATS-SMFT 780: Option

Maximum expansion: 8 boards (=384 stimulus channels)

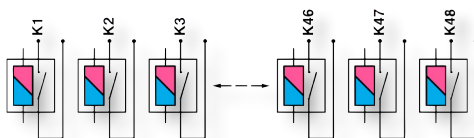

### HSM670 High Voltage Stimulus Matrix

The high voltage stimulus matrix with 16 channels is used for switching stimulus signals with high voltages. Max. 4 boards can be used in the test system. DC max. 250 V, max. 10 A, max. 300 W, AC max. 250 V, max. 10 A, max. 2,500 VA.

ATS-MFT 770: Option

ATS-SMFT 780: Option

Maximum expansion: 4 boards (64 channels)

### PMX16 Power Matrix

The power matrix with 16 channels is used for switching stimulus signals with high DC- and AC-current. Max. 4 boards can be used

in the test system. The module takes one slot. DC max. 100 V, 10 A, max. 1,000 W switching power.

ATS-MFT 770: Option

ATS-SMFT 780: Standard

Maximum expansion: 4 boards (64 channels)

## SBus

The SBus is used for applying sources such as function generator, PSUs etc., but as well any external signals to every point where the measuring matrix channels are connected to. You can measure any time in parallel to the stimulation. Because of its open make-up you can e. g. apply a logic channel to any measuring point or to several measuring points.

## RMX 96 Measuring Matrix

The basic version of ATS-MFT 770 includes a measuring matrix boards with 96 measuring channels. On the measuring matrix board there are selected miniature single-in-line-relays. There are three relays for each channel so that you can select either high, low or guard. Switching power is 10 VA, max. 100 V, thermo-electric voltage is far below  $50\mu\text{V}$ .

ATS-MFT 770P: Standard 2 pieces

ATS-MFT 770B: Standard 1 piece

ATS-SMFT 780: Standard 5 pieces

Maximum expansion:

ATS-MFT 770: 15/45 boards (= 1,440/4,320 measuring channels with an additional rack

ATS-SMFT 780: 23/41 boards (= 2,400/3,480 measuring channels with an additional rack)

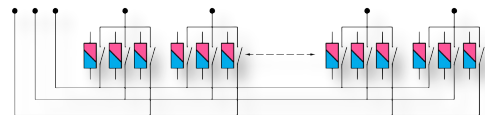

## Measuring-Logic-Stimulus Matrix RML32

The optional RML32 is a combined measuring matrix, stimulus matrix and logic board. With this module, you can apply analog voltages to the measuring bus, you can connect stimulus devices such as power supply units, generators etc. to the test item and you can apply and check digital signals. The RML32 measuring-logic-stimulus matrix only has one maker per channel. The driver levels are programmed between 3.3 V and 5 V. There are no comparators for evaluating the applied voltage values. The input and output levels can be checked, but the levels for discerning high/low are set. The output of the pseudo PSU can be used as an additional voltage supply, 5 V or 3.3 V.

ATS-MFT 770: Option

ATS-SMFT 780: Option

Maximum expansion: 8 boards (= 256 measuring and logic channels, 192 stimulus channels)

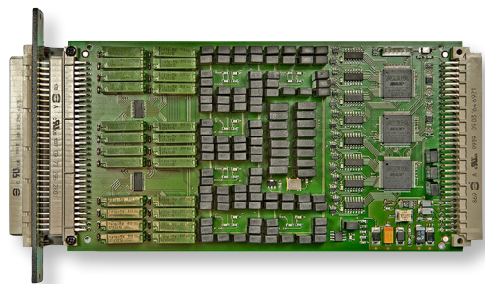

## VMX8 High-Voltage Measuring Matrix

VMX8 High-voltage measuring matrix is a board for the combined In-circuit- and High-voltage functional test, which often tests typical voltages up to  $230 V_{\text{eff}}$  or overvoltages up to  $280 V_{\text{eff}}$ . With this high voltage measuring matrix, up to 420 V may arise without endangering the measuring relay, whereas in classical reed-relay technique, the relay voltages of the Reed-contacts are limited to 100 V or  $200 V_{\text{pk}}$  resp. and therefore can no longer be used for functional test under mains voltage. Because of the larger relays and clearances, there are only 8 channels available on this board, which can be expanded at any time.

The example shows a PSU where ICT1 to ICT10 are to be contacted with a VMX8 High-voltage measuring matrix board.

ATS-MFT 770: Option

ATS-SMFT 780: Standard

Maximum expansion: 8 boards (= 64 measuring channels)

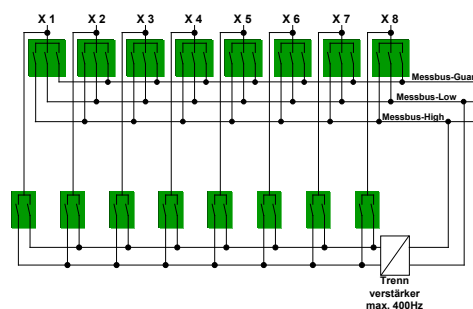

## ZDC100 Zener Diode Measuring Board 100 V

The optional ZDC100 module is for measuring Zener diodes with more than 25 V. The plug-in board holds a programmable current source with 3 different voltage measuring ranges, 0–50 V, 0–75 V and 0–100 V. Current can be set in steps 1 mA, 5 mA and 10 mA. With relays the voltage is applied to the measuring bus and via the RMX-channels it can therefore be applied to any measuring point. A high voltage discharge source on the plug-in board can be discharged with max. 100 mA. The discharge source can also be used with normal capacitor discharges. The sources are directly applied to the measuring bus.

A potential-free PSU on the ZDC100-board provides a potential-free voltage of 25 V, max. 1 A which supplies modules in Function test.

## LOG670 Logic Boards

The LOG670 logic board has got 32 bi-directional channels and tests any kind of logic. The driver level can be set between 0 V and 30 V. Comparator high- and low-level can also be set. The driver high-level must always be above the comparator high-level so that the high-level is controlled automatically. Each channel can be driver, comparator or Tristate or switch off fully automatically from its surroundings. The driver and comparator level can vary in every test step. With a second logic board, you can handle two logic families at a time (e. g. 3.3 V logic and 5 V-logic). Connected with the measuring channel, it can be switched as a hybrid channel.

ATS-MFT 770: Option

ATS-SMFT 780: Standard

Maximum expansion: 8 boards (= 256 logic channels)

## LOG96 Logic Boards

The levels of the logic board with 96 logic channels can be set to 5 V or 3.3 V. Other than the LOG670, LOG96 has no programmable comparators for evaluating the applied voltage values. Nevertheless, the input and output levels can be checked with set levels for discerning high and low. Levels from 0–0.8 V are discerned as low and levels from 2.0 V–3.3 V / 5 V are discerned as high.

ATS-MFT 770P: Standard

ATS-MFT 770B: Option

ATS-SMFT 780: Option

Maximum expansion: 3 boards (= 288 logic channels)

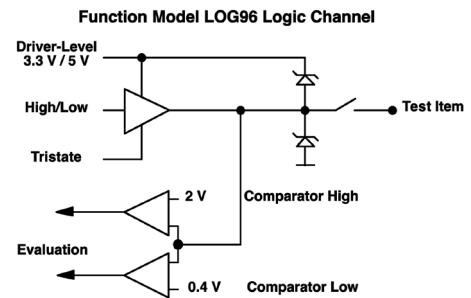

## PML670 Precision-Measuring-Logic Board

Digital functions can be stimulated and evaluated with this optional module. Each of the 16 channels can be switched as input or output. Different voltage levels can be stimulated or evaluated at the same time. Each output of the PML670 can provide a precise voltage from 0.1 to 30 V. One channel can be loaded with 50 mA. The total current of the 16 channels may reach up to 500 mA. The test item can be stimulated with 16 different voltages at the same time.

This module may also be used for 16 channel-parallel- measurements, which grants very short measuring times.

ATS-MFT 770: Option

ATS-SMFT 780: Option

Maximum expansion: 8 boards (= 128 channels)

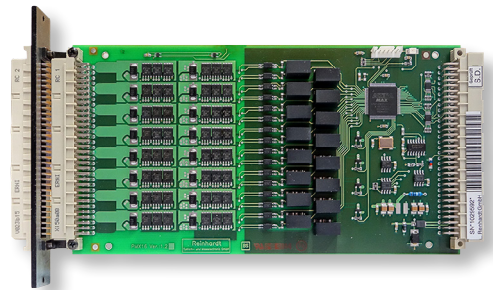

## Serial Logic Data – Serial Field Bus Systems

The basic version of the test system always comes with the I<sup>2</sup>C-Bus, USB2, TCP/IP (the latter two via VISA.driver) and RS232-interface. For GPIB/IEC-/IEEE-stimulus and measuring tasks there is an optional board/interface for connecting all measuring devices common in the market such as e.g. Keysight, Tektronix, Philips, Fluke, Rohde & Schwarz so that they can be operated as comfortably as a stimulus or measuring unit of our test system. The CAN-bus can be used via a system-internal option. About 24 other fieldbus systems (PC-cards) can be built into the PC and can be addressed and evaluated comfortably by our software-windows.

## Transient Recorder (Oscilloscope)

The 64k deep REINHARDT-transient recorder with 12 bit resolution offers 50 MHz bandwidth with max. 250 MHz sample rate. Max. input voltage is  $\pm 100$  V at min. 250  $\mu$ V resolution. Out of the curve forms it measures parameters such as frequency, period, rise time, fall time,

pulse widths, peak voltage, distortion factor, Fourier analysis etc. Envelopes are for automatic evaluation of curve forms. 8 HF-input channels and 9 NF-input channels are available, but the transient recorder can also be used on the standard measuring bus provided by the test system. An external trigger input is also available. Input impedance can also be programmed, 1 M $\Omega$  or 50  $\Omega$  and a second order filter can be connected.

The transient recorder records analogue signals from an input voltage range from  $\pm 1$  V,  $\pm 10$  V and  $\pm 100$  V and displays them graphically. The time base from 10 ns to 5 s can be pre-set. You can trigger both internally and externally – AC and DC-coupling can be pre-selected as well as the level for triggering. In digital recording, the history of a signal before the triggering point can be recorded and displayed. The signal recorded in this way, be it sine or any pulse form, can be evaluated fully automatically with envelope curves of 2,000 points. For evaluation, there are of course separate measurements such as peak to peak, peak, rise time, fall time, pulse widths and frequency or periods. There is a Fourier analysis as well as a measurement of the distortion factor.

ATS-MFT 770: Option

ATS-SMFT 780: Standard

Maximum expansion: max. 4 boards cascadable

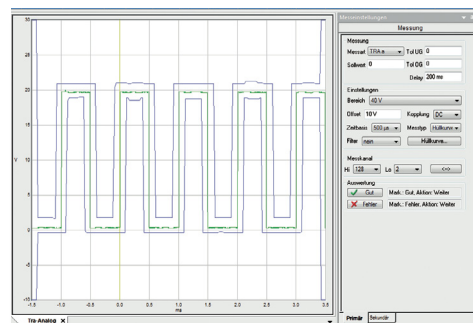

### Resistance Decade and Motorised Trimmer (Option)

For adjusting circuit functions, you must select resistances so that the function can be measured. The resistance you have found ought to be edited and set for the function you really wanted to reach. The resistance decade generates resistances in the range between 1  $\Omega$  and 16.777 M $\Omega$  with 1  $\Omega$  resolution. A fixed value may be set, e.g. for simulating a thermistor, but there may also be incrementing or decrementing in any  $\Omega$ -step you like or in the E-series E12, E24, E48 and E96.

With our motorised trimmer you adjust under system control. It is used especially for spindle potentiometers with 20 to 30 rotations as well as for 270°-potentiometers. As in many real tasks we test the circuit functions in the end position of the potentiometer clockwise and anticlockwise and within a few seconds adjust it to the desired value. With the motorised trimmer, you can adjust to desired value, min- and max-value, endposition clockwise and anticlockwise. This option includes the plug-in board and its electronics and a motorised trimmer which can be delivered with different blades, just as needed. Both Resistance Decade and Motorised Trimmer are on one plug-in board.



### Additional Voltage Sources (Options)

In case you need more voltage sources than those included, we supply additional voltage sources:

#### 1. **NGS 470/670** Three-fold PSU

NGS470/670 requires 3 plug-in positions and offers three sources. It generates voltages in the range between 0 V and +8 V and a current between 0 A and 4 A, resolution 2 mV or 1 mA resp. Two DC voltage sources can be programmed in the range from 0 V and +38 V and 0 V to -38 V and a current of 1 A. Resolution is 10 mV or 0.25 mA. This voltage source is monitored for thermal overload.

#### 2. **ENG-60V** Potential-free two-fold PSU

The ENG-60V voltage source offers 4 \* 15 V fixed or 2 \* 2–26 V at max. 200 mA. When the standard PSU 0 V–38 V is switched in series, DC-voltages up to 98 V are possible. ENG-60V can be adjusted via voltage divider (LM317). For additional expansions, there is a hole grid area on the board.

### Additional Load (optional)

Apart from our integrated load, there is **LA670** with 4 single loads. These loads are potential-free. Maximum current is 4.096 A. Maximum voltage is 50 V, resolution is 12 bit. This board is thermally controlled.

### AC-Voltage Source 280 VAC – 350 VDC (optional)

In electronics there are many measuring modules, time relays and other transducers. These modules need an AC voltage of 230 V and the corresponding minimum and maximum values. **AC670** requires three plug-in positions and generates AC voltages in the range of 0 V to 280 V. Resolution is 12 bit, maximum power is 45 VA. Output current is programmable, resolution is 12 bit. Frequency of the AC voltage is variable and can be programmed between 25 Hz and 6.500 kHz in 0.1 Hz-steps.

This board can also be used as DC-source and generates DC-voltages from 0–350 V with 12 bit resolution. current limitation can be programmed from 0–100 mA with 12 bit resolution. Maximum power is 35 VA.

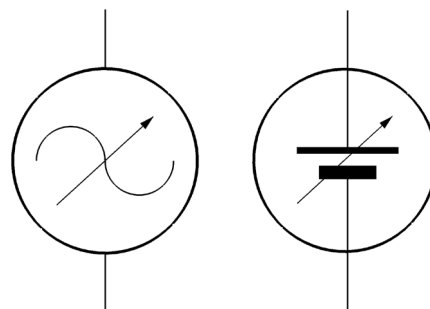

### Expansion Power Matrix (optional)

For switching high currents and voltages, we have the optional **LMX670** power matrix. It is contacted by high current contacts and offers 8 normally open contacts. It takes two board positions. Maximum breaking voltage is 300 V<sub>eff</sub> or 425 V<sub>pk</sub> (AC) and 300 VDC. Maximum current is 16 A. The LMX670-module further holds 8 high voltage measuring channels which measure peak or DC voltages up to 420 V with 0.5% +0.1 accuracy.



### Function/Arbitrary Waveform Generator (optional)

By standard, ATS-MFT 770 or ATS-SMFT 780 is equipped with a generator from 0Hz to 500kHz for sine and square wave which is sufficient for most of the test tasks. Another two generators are for higher frequencies and can be programmed from 1  $\mu$ Hz to 20 MHz or 1  $\mu$ Hz to 80 MHz. We describe the 20 MHz generator below, as both generators operate very similarly and differences arise in the peak values only. Apart from sine, square wave, triangle, sawtooth, noise and pulse signals, these generators offer arbitrary functions in order to create any curve forms. As all our modules, they are programmed very comfortably in our windows. The pictures show some examples. Frequencies from 1  $\mu$ Hz to 20 MHz are available, resolutions can be set from 1  $\mu$ Hz over the complete frequency range. Burst and wobble is also possible with this generator. The amplitudes are programmed between 20 mV<sub>pp</sub> and 20 V<sub>pp</sub>. Ramps can be programmed up to 200 kHz with 20 ppm accuracy. The generator provides a defined burst signal output. In this way it can output a certain kind of periods of any signal. Maximum frequency in the burst mode is 5 MHz. Repetitions can be programmed from 1 to 50,000 or infinite repetitions. The start phase can be programmed from -360° to +360°. It can be programmed flat or logarithmic with 10 MHz minimum start frequency and 15 MHz maximum stop frequency. Trigger sources can be single, external or internal.

### System Diagnose and Calibration Device (optional)

With the system diagnose and calibration device you can calibrate your test system on your own in a very short time (about 30 minutes) without calling the REINHARDT-service. This saves down time as well as cost. The found results are documented in a record which can be printed. The complete reference and test electronics are in a cabinet, sized 420 x 403 x 125 mm. The calibration and system diagnose device contacts all sources, measuring units and matrix channels after it is plugged on in a plug-and-play procedure. Depending on the expansion of the test system, the calibration device can be expanded with further modules at any time. All the calibration modules themselves are connected by a bus, which contains I<sup>2</sup>C-Bus, measuring bus, voltage supply etc. All reference values which are found by our special software are written into the single EEPROMs of the calibration and system diagnose device. With the calibration and system diagnose device, you can find out at any time if your test system works properly and within its specifications. This is often very comfortable if you are not sure if your test system is defective. It helps you to find defects precisely to the test system board or even the very component within a few minutes. The calibration and system diagnose unit also supports our service technicians if you call for support and repair on the phone. It also helps to adjust e.g. the Analog-Digital-measuring unit.

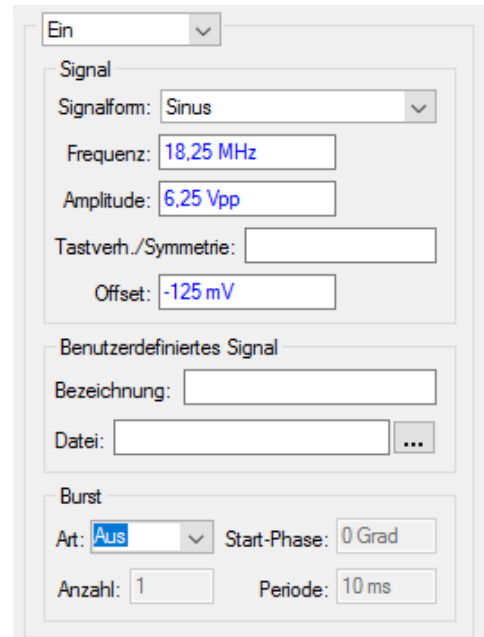

*Settings Curve Form Generator*

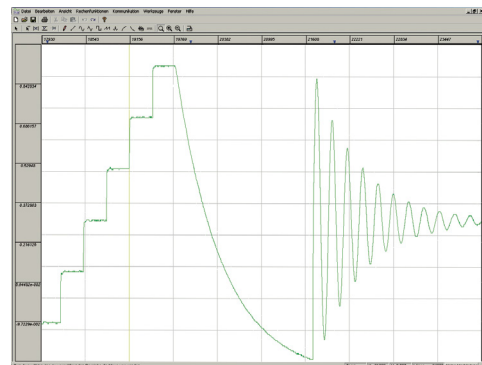

*Curve form editor of the function- and arbitrary generator*



The calibration and system diagnose device can be calibrated at REINHARDT – we recommend a 1–2 years interval.

### Interface

At the front of ATS-MFT 770 there are, depending on its equipment, a number of DIN 41612 64/96pole VG connectors. They connect the device under test or the fixturing system. Adaptors connect the connectors to the electronics. After mechanical stress, wear or a defect, they can be exchanged in about 1 minute – you only have to unscrew two screws. The multipoint connectors are vertical and can be connected with a male VG multipoint connector. There is a number of fixturing systems for function test/in-circuit test which can be docked to the REINHARDT SR18VG interface.



*ATS-MFT 770 Front – Interface*

### Universal Exchange Fixture

We have developed our multi-function test systems especially for middle to small-sized boards. Very much like our standard fixture, we connect the exchange fixture system to our compact multi-function test systems in a single plug-in procedure. On the upper side of this fixture, there is an exchange plate (fixture plate). These fixtures are used with up to 12 multi-way connectors for both in-circuit and function test. What is most advantageous about this system is that it costs only fractions of a complete fixture and takes only little space for storing (For more details, please see the last pages of this booklet). This exchange plate system can be used for function and in-circuit test in retention but also in vacuum technique. Even smallest lots are then tested in a cost-effective way.



*Type 42A Universal-Exchange Fixture*

### Ergonomic Profile Desk (optional)

All industrial work tables with 19"-sub-desks are designed in such a way that left and right of the central work place there is no legroom. Therefore we have developed an ergonomic work place whose sub-desks are all set back over the complete front so that the user enjoys legroom over the complete desk width and does not have to do without the 19" wide sub-desks. There are two versions of this working desk, either with two or three 19", 12 HU-sub-desks which can also house the control PC. Optionally, this desk can be equipped with spacious 3 HU drawers which can hold technical documentation etc. As an option, the 19"-sub-desks can be delivered with doors. Behind that you can mount receptions for the universal-exchange plates with bed-of-nails (380x230 mm). Up to 5 exchange plates can be housed in a sub-desk. Dimensions: Width ca. 1,780 mm, depth ca. 900 mm



*Profile desk (picture with optional test system with accessories)*



### Profile Cabinet (optional)

For an optimum work place we also offer a 19" wide profile cabinet which can be a sit or a stand workplace and which also houses the control PC. This cabinet can be equipped with spacious 3 HU drawers which can hold technical documentation etc. The profile cabinet is ready for receiving power electronics such as e. g. REINHARDT-power modules or additional stimulus and measuring devices.

Dimensions: Height incl. feet 1,950 mm, approx. depth incl. working desk 1,420 mm



*Profile cabinet (Picture with optional test system with accessories)*

## Extended Tasks Using Power Electronics

Most producers of test systems do not provide power electronics, but offer only low voltage current solutions. By contrast, REINHARDT offers special modules for testing power electronics.

The ATS-MFT and ATS-KMFT family can include all REINHARDT power electronics devices. All these tasks can easily be executed with our menu-driven software. For programming in the DC voltage range, there are several sources:

**DC 30/25 DC-source**, 0–30 V, 0.6 mV resolution, 0–25 A, 0.5 mA resolution, can be programmed in current and voltage; OVP; incl. RS232-interface and connection cable, ½ 19" unit, 1 HU, 482 mm deep, 7 kg

**DC 60/12.5 DC-source**, 0–60 V, 1.2 mV resolution, 0–12.5 A, 0.25 mA resolution, can be programmed in current and voltage; OVP; incl. RS232-interface and connection cable, ½ 19" unit, 1 HU, 482 mm deep, 7 kg

**DC 600/1.3 DC-source**, 0–600 V, 12 mV resolution, 0–1.3 A, 0.03 mA resolution, can be programmed in current and voltage; OVP; incl. RS232-interface and connection cable, ½ 19" unit, 1 HU, 482 mm deep, 7 kg

**DC 600-4 DC-source**, 0–600 V, 0–4 A, 2,400 W, can be programmed in current and voltage, incl. RS232-interface, 19" unit, 1 HU, 480 mm deep, 8.5 kg

For programming in the **AC voltage range**, there is also a number of external sources:

**AC 300/500**, one-phase electronic AC-source and DC-source, max. 300 VAC in 2 ranges, max. currents 4 A/2 A, 500 VA, frequency resolution 0.1 Hz, voltage 0.1 V resolution, current protected mode in 0.02 A-steps (AC and DC), frequency range 15 Hz–1 kHz, DC 0–212 V, 2 A, 213 V–424 V, 0.1 V resolution, 1 A, 3 HU, 19" wide, 570 mm deep, 21 kg, RS232-/GPIB-interface

**AC 300/800**, one-phase, max. 300 V in 2 ranges, max. currents 5 A/2.5 A, 800 VA, frequency resolution 0.1 Hz, voltage 0.1 V resolution, frequency range 45–500 Hz, 2 HU, 19" wide, RS232-interface

**AC 300/1000**, one-phase electronic AC-source and DC-source, max. 300 VAC in 2 ranges, max. currents 8 A/4 A, 1000 VA, frequency resolution 0.1 Hz, voltage 0.1 V resolution, current protected mode in 0.02 A-steps (AC and DC), frequency range 15 Hz–1 kHz, DC 0–212 V, 4 A, 213 V–424 V, 0.1 V resolution 2 A, 3 HU, 19" wide, 570 mm deep, 21 kg, RS232-/GPIB-interface

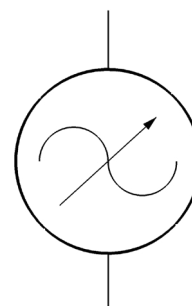
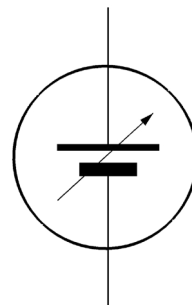

The **POMO80 power module** was designed for the 48 V-technology which is very common in the automobile industries which requires test voltages up to 70 V. They are especially used in the automobile range for simulating the voltage of the vehicle electrical distribution system. During the start procedure in winter this voltage often breaks down in a sinusoidal way between 6 V and 9 V.

The DC-modules are linear-controlled and can be started and turned-off in any form of ramp as can the loads (soft-start). Ramp and curve functions can be edited, also for DC. The loads can be modulated up to 50 kHz frequency, the starting current can be set. Via the USB-interface there is a standard possibility of re-reading the true-values. Total power is up to 1,000 V. A system diagnose and adjustment of the modules is possible by correction values which are stored in an EEPROM. The customer can thus check and calibrate his unit at his site.

Dimensions: 19", 3 HU, 450 mm deep, weight 25 kg, can be delivered as a 19"-desktop unit or a 19" build-in unit (please advise in your order). There are 7 variations of the unit (For variations and technical data please see the table in the measuring ranges.).



### High Voltage Protection – Protection Module for the In-circuit-Test

Relays and inductive components may occasionally cause peak voltages up to 3,000 or 4,000V when voltages are turned off. These high voltages may damage the test system. With the high voltage protection module these voltages are limited by very fast switching bidirectional suppressor diodes at ca. 100V. The low capacitance of ca. 500pF have little effect on the In-circuit test. This module with 64 diodes is mounted to the RMX-connector of the exchange plate.

### High Voltage Test

according to the safety regulations up to 2,500V or 3,000V is not possible with our test systems.

#### HVT 16 Voltage Divider for Measuring up to 1,000V

For measuring up to 1,000 V with our multi-function test systems, we have developed a voltage divider module with 16 channels. They can be expanded as needed. The module is plugged onto the connector in your test fixture and connected to the pins via wire wrap.

### Test Fixture with Stimulus and Measuring Modules

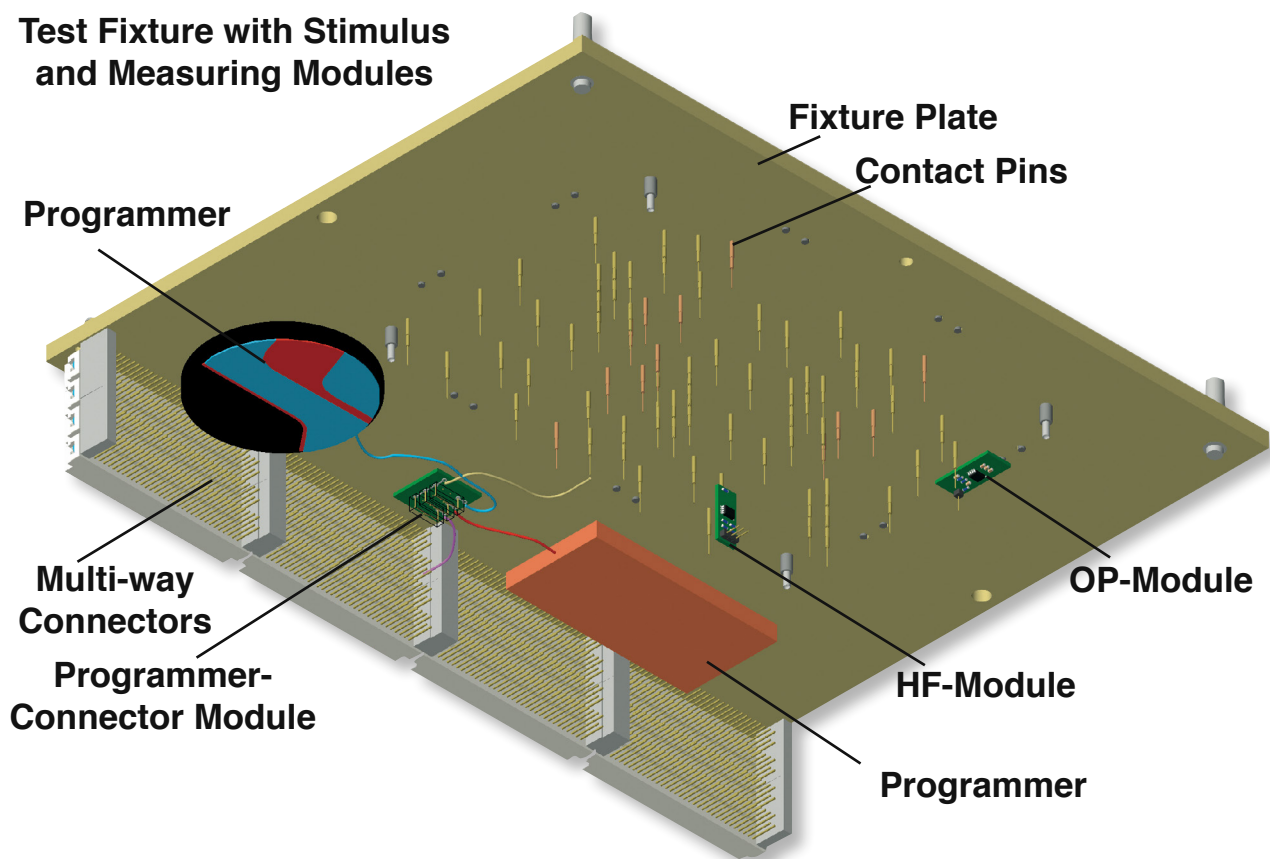

### Support Modules For Mounting into the Fixture

For special tasks which cannot be solved sufficiently by the test system, we have developed a number of modules which are mounted into the fixture. These are small modules, typically sized 10x13 or 13x29mm. In most cases they are mounted to the test pin so that the cables have minimum length.

These modules are supplied by a voltage supply module which takes its operating voltage from the test system. The I<sup>2</sup>C-Bus signal is also applied in this module and is necessary for the stimulus modules for voltage, current, frequency and pulse.

### HFMOD High Frequency Measuring and Dividing Module 200–1,100 MHz

With the small HFMOD-Module you can measure high frequency voltages between 0.5 mV to 3 V which are divided by 128 via a high frequency divider. The output of this module is connected to a measuring channel of the test system. It is evaluated by the REINHARDT-measuring unit in the ZME measuring range.

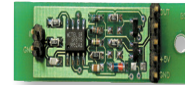

### HFPKMOD Peak Voltage Measuring Module

This measuring module changes peak voltages up to max. 100 MHz into a DC-voltage which can then be measured by the test system. This only works with voltages above 400 mV, as it is done with a passive peak value rectification.

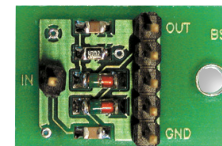

### OPAMOD Impedance Transformer

This buffer module has got 1 T $\Omega$  input impedance at 8 pF. In the +/-10 V voltage range it creates an identical output voltage. The impedance transformer can be used up to 150 kHz.

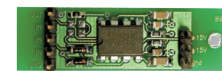

### OPTOMOD Opto-Coupler Module

Depending on its use, there are different signals in the items to be tested on various potentials. With the input/output isolation module, made up of two opto-couplers, they can be measured without loading the item under test unnecessarily. Signal amplitude is 0 V to 5 V, maximum usable frequency is 5 MHz.

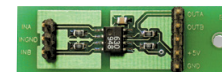

### STROMMOD Current Measuring Module

The module is equipped with a shunt and an operational amplifier and changes the voltage that falls at the shunt into a ground-related voltage. With various shunts or the Gain-resistance, the module can be adapted to the various requirements.

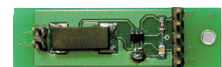

### DACMOD Current and Voltage Supplier Module

The module is controlled by I<sup>2</sup>C-Bus and generates voltage or constant current. Voltage range is between 0 and 10 V, current range is between 0 and 25 mA. Resolution is 12 bit.



### GenMOD Sine and Square Wave Module

The module is controlled by I<sup>2</sup>C-Bus. The GenMOD creates output frequencies between 1 Hz and 65 kHz. Resolution is 1 Hz. Output voltage in the sine range is 5 V<sub>pp</sub>, square wave output is a TTL-output.



### HFGenMOD HF-Square Wave Module

The square wave generator module creates a fixed square wave frequency. Output frequency is set via two potentiometers (coarse and fine). Various frequency ranges are selected via coding connectors. Maximum output frequency is 30 MHz.



### PGENMOD Pulse Generator Module

The module was developed for additional generator stimulating. It creates the following signals: square wave signal on output 1, phase-shifted square wave signals on all three outputs and burst-impulses. There is a RISC-processor (PIC) which is controlled by I<sup>2</sup>C-Bus and three output transistors whose open-collector level is by standard bridged to +5 V. By applying an external driver voltage and converting a jumper, the level can be changed to up to 25 V. This module can program frequency from 1.1 Hz to 5 MHz and generate pulse width from 50 ns to several hundred ms.



### ReIMOD Relay Module

This module switches max. 200 V and 0.5 A at 10 W maximum power. There is one normally open contact. The coil resistance is 500 Ω. The coil is switched with 5 V.

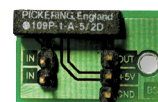

### HVReIMOD High Voltage Relay Module

This module switches operating voltages up to 250 V<sub>eff</sub> at 5 A current with max. 1,000 VA power. There are 2 normally open contacts. The coil resistance is 130 Ω. The coil is switched with 5 V.

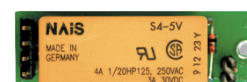

### AdapLMXModule

This board is mounted to the exchange plate. The board can be addressed via RS232-interface or I<sup>2</sup>C-bus via the test system and supplies 8 relays and 2 control bits for the function test. The relays of channels 1–4 can switch voltages of 250 V and currents of 4 A at max. 1,000 VA. The relays of channels 5–8 can switch 16 A at 250 V and max. 2,000 VA. Power switching is available within the fixture plate.

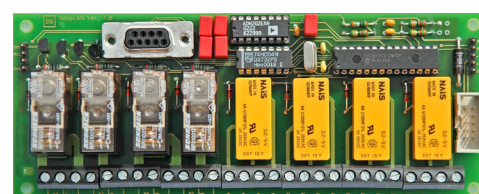



### MicMod Microphone Module

With the microphone module you can check sound outputs of you component. On the module there is a microphone and an amplifier. The amplifier output signal is wired to the measuring matrix channels of the test system which then evaluates frequency and amplitude. Amplification can be set in three levels.

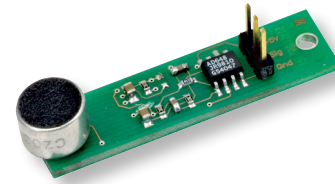

### FARB-LED-Module

The microprocessor-controlled LED-test module evaluates LED-colours. A sensor with configurable colour diodes separates the light colour into its red, green and blue shares. A PIC-processor returns the RGB-values via I<sup>2</sup>C-bus as evaluation. A colour shade is calculated which is used for colour evaluation. With a lighting-LED, a surface colour can also be evaluated. The module can also be used without I<sup>2</sup>C-bus; then the PIC-processor creates two voltage outputs with values between 0–5 V which are proportional to luminosity and colour value.

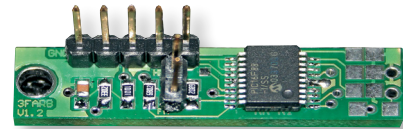

### 16FARBMod Module

The 16FARBMod module was developed for evaluating colours and intensity of LEDs automatically. 16 identical sensors on the board use their configurable photo diodes to separate the light colours into their red, green and blue shares. Interpretation and evaluation is via a PIC-processor which returns the RGB-values and the HSV-colour value as evaluation. Communication is via I<sup>2</sup>C-bus or alternatively via RS232.

The sensors cover the colour range 300 nm to 700 nm. Light current is supplied by glass fibre.

In the basic version, there is the evaluation module and 8 waveguides. Another 8 waveguides are optional.

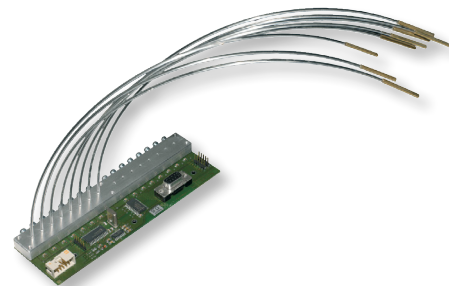

### TempMOD Temperature and Humidity Measuring Module

The TempMOD Temperature and humidity measuring module measures temperature and humidity via the I<sup>2</sup>C-Bus. The 3.3 V supply voltage is generated by a voltage regulator.

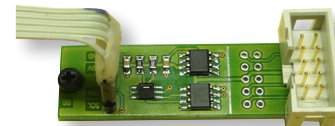

### Spring-suspended Switch Contact Pin

With this spring-suspended switch contact pin you can find out, if a component is loaded or scan markings or codings. In this contact pin, there is a switch which closes when the contact pin is pressed in. The spring-suspended contact pin incl. receptacle has got an outer diameter of 1.7 mm.



### Pneumatic Contact Pin

The contact pin has got an outer diameter of 3 mm plus receptacle and is activated by a pneumatic valve. A critical joint is only contacted when it is necessary so that it is not loaded during the test procedure.



### Programmer-Connector Module ProgMOD16

The ProgMOD16-module is used for interconnecting the programming connections. The ProgMOD 16 Programmer connector module is a 3fold exchangeable module for up to 8 connections, in order to either connect an RMX-channel or two different programming connections to the test pin and reduce interferences. There is a connector for up to 2 JTAG-programmers (e.g. J-Link, Olimex, REINHARDT RBS100,...) to directly plug in the programmers. There is also a connector which fits the PICKit2 or PICKit3 by Mikrochip.

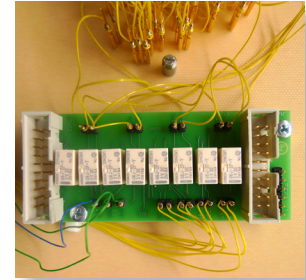

### Electronic Actuator M12

The electronic actuator M12 moves keys and switches in case there is no compressed air. The shift of 12.7mm can be programmed in 170 steps. An integrated worm in the stepping motor changes the rotation into a travel movement. The actuator module is controlled via I<sup>2</sup>C bus or via 2 pins which are used for selecting 3 fixed positions.



### SteuerMod-Inline USB-Module

As communication interface to a SPS, the SteuerMod-Inline USB module can be used to integrate a test system into a production line. The module is built into a top-hat rail housing. With a screw clamp it can be connected to an SPS. Its USB-socket is used to connect it to the control computer. A lamp control is integrated. A red light indicates a faulty and a green light shows a faultless test run. Blue shows e. g. a Stop which indicates that the operator has to intervene.

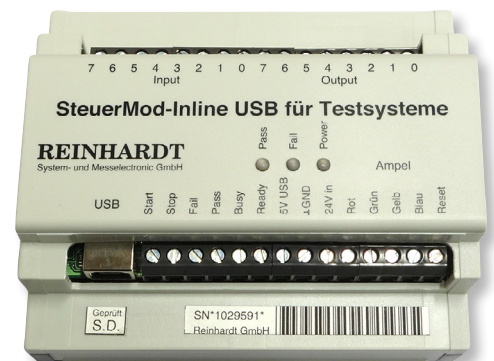

### Start Stop Steuerung USB-Module

The Start Stop Steuerung USB-module is a start-/stop key for the test systems. Alternative start-/stop impulses can be created with lighted metal buttons which are normally moved by the RETURN/ESC-key on the keyboard or with the mouse. Communication is via USB.





### TrigMessMod

The TrigMessMod is for measuring a triggered voltage, i. e. a voltage that is controlled by another signal in the range between 0–5 V. This measurement is executed on the module. The time of the measurement is triggered via TTL-input and can also be postponed with a programmable delay time.

If the module is slightly modified, the voltage range can also be adapted to smaller or negative voltages.

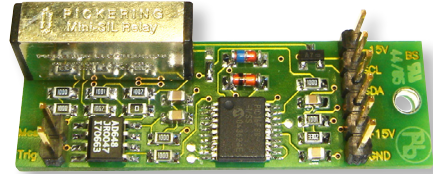

### ADAEEP Fixture Recognition Module

A fixture or an exchange plate can be assigned to a project. The assignment is written to an I<sup>2</sup>C-EEPROM, address 166, on the ADAEEP. When the fixture or exchange plate is changed, the test system-software automatically loads the respective project or warns if a project that is not assigned is to be loaded manually.

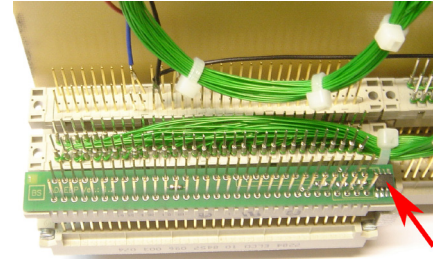

### Circle Marker

The electric circle marker for marking tested PCB engraves the PCB with a 2 mm circle and requires 6–12 VDC for control. With a fixing angle, the electric circle marker can be fixed to the retention exchange box for REINHARDT-fixtures.

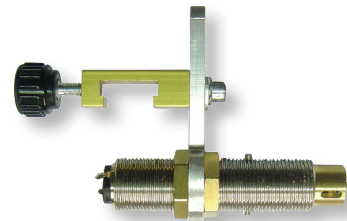

### DUT\_LED Module Optical Display of Status

When e.g. multiple printed panels are tested it may happen that you no longer know which panel has already been tested and if it was good or faulty. The DUT\_LED module can be mounted on the exchange plate. The red LED displays the faulty, the green LED the good test run and a blinking yellow LED displays the busy-mode. A prompt if the test item was removed is also possible. Communication is via the I<sup>2</sup>C-Bus.

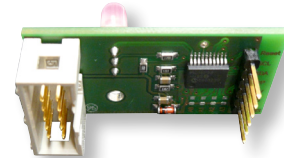

### BEE-Module – Recognition if a Board is Placed or Removed

The module recognises if a board (PCB) is placed in the fixture with bed-of-nails or if it has been removed while the fixture was not contacted; retroreflective sensor, class 1M laser (invisible laser radiation, do not view directly with optical instruments), 5 VDC-supply, max. 50 mA, digital output, sensitivity can be set.

We recommend the DUT\_LED-module for optical evaluation and display.

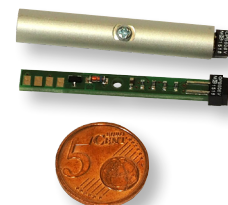

## Measuring Ranges

### In-circuit Test

#### Pin Contact Test

The pin contact test confirms whether the wired measuring channels and test item contacts have a resistance of less than 30 M $\Omega$  or a capacitance of more than 100 pF...10 nF relative to the system pin. This is useful for example in checking whether a test pin has jammed or is contaminated with flux. Learning a pin contact test checks if there is an Ohm or a capacitive connection to the system pin. The result is saved in a test project. The test time depends on the learnt measuring method and can be between 5 ms and 65 ms.

**Measuring method R:** A constant voltage is generated and applied to the test item via a series resistance. The voltage drop at the test item is measured and evaluated. In the learning procedure, the measuring direction is learnt so that the diodes are captured correctly. We use series resistances of 100 k $\Omega$  and 1 M $\Omega$ .

**Measuring method C:** The standard-C measurement in the 1 nF-range is used (please see paragraph C-Measurement) for this measurement.

Meas.Mode	Meas.Range max.	Series Resistance	Test Voltage max.
R	30 M $\Omega$	1 M $\Omega$	5 V
C	1 nF	1 k $\Omega$	200 mV <sub>pk</sub>

#### Net Test (Continuity Test)

There is a net (continuity) if the resistance between two pins is below the net threshold value. The net threshold value can be set between 5  $\Omega$  and 5 k $\Omega$ .

**Measuring method:** A constant voltage (0.2 V) is generated and applied to the test item via a series resistance. Up to a net threshold value of 30  $\Omega$ , the series resistance is 10  $\Omega$ , above 30  $\Omega$ , it is 1 k $\Omega$ . The voltage drop at the test item is measured and evaluated.

Meas. Range	Meas.Time	Test Voltage max.
5 $\Omega$ –5 k $\Omega$	5 ms per test step	0.2 V

#### Isolation Test

In the isolation test, existing circuit continuity is tested to check whether the resistance between circuits is below the value given in the continuity test. (There is a field for changing the default limit value for isolation test eg. 5  $\Omega$ –5 k $\Omega$ .) We use the same measuring method as in net test.

Meas.Time	Test Voltage max.	Test Current max.
5 ms per test step	0.2 V	20 mA

### SMT Solder Defect Test

The IC-Open Test (IC Solder defect test) was developed for SMT-components on bus systems.

**Method:** With the fixture the IC-Open Probe is applied from above to the IC under test. All inputs of the IC (connection pins) are connected to ground. Ground is then disconnected from one pin after the other and a signal of 8 kHz and a voltage of 141 mVeff is triggered. If the pins are connected, there is always a coupling to the IC-Open probe. The AC-signal received is amplified by a selective amplifier and can then be evaluated by the test system. Measuring time is about 10ms per pin.

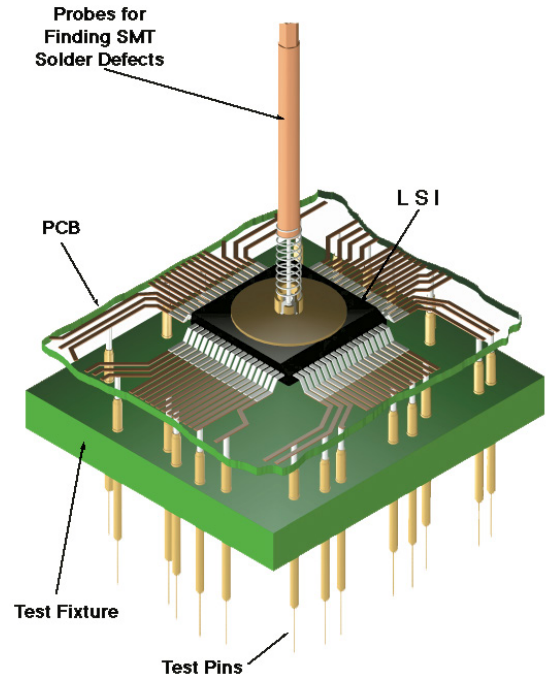

### R-Measurement

Resistance measurement is in 8 ranges. The accuracies given below were found in a four-terminal measurement. In four-terminal resistance measurement, the measuring time rises by 10ms. You can choose from four measuring speeds. For the four-terminal measurement, you need an MMX670-stimulus matrix (standard equipment in ATS-MFT 770).

The measuring range of resistance measurement is 0 Ω to 40 MΩ. In the ranges from 0 Ω to 400 kΩ, max. evaluation voltage is 200 mV, in the 400 kΩ to 40 MΩ ranges max. evaluation voltage is 2 V.

With the measuring times given below, all relay switching times have been taken into account.

Selected speed: **extra**

Meas.Range	Full Scale	Resolution	Meas.Current	Meas.Time	Accuracy %*
0 Ω–4 Ω	0 Ω–4.000 Ω	244 μΩ	50 mA	3.6 ms	1.5+0.5
4 Ω–40 Ω	0 Ω–40.00 Ω	2.44 mΩ	5 mA	3.6 ms	1.5+0.5
40 Ω–400 Ω	0 Ω–400.0 Ω	24.4 mΩ	0.5 mA	3.6 ms	1.5+0.5
400 Ω–4000 Ω	0 Ω–4000 Ω	0.244 Ω	50 μA	3.6 ms	1.5+0.5
4 kΩ–40 kΩ	0 kΩ–40.00 kΩ	2.44 Ω	5 μA	3.6 ms	2.5+0.5
40 kΩ–400 kΩ	0 kΩ–400.0 kΩ	24.4 Ω	0.5 μA	6.7 ms	7.5+0.2
400 kΩ–4 MΩ	0 MΩ–4 MΩ	244 Ω	0.5 μA	11.2 ms	10+0.1
4 MΩ–40 MΩ	0 MΩ–40.00 MΩ	2.44 kΩ	50 nA	22 ms	10+0.5

\* The first value is in percent of the measured value, the second value is in percent of the measuring range. Standard settings are marked in grey.

Selected speed: **fast**

Meas.Range	Full Scale	Resolution	Meas.Current	Meas.Time	Accuracy %*
0Ω–4Ω	0Ω–4.000Ω	244 μΩ	50 mA	4.4 ms	0.75+0.5
4Ω–40Ω	0Ω–40.00Ω	2.44 mΩ	5 mA	4.4 ms	0.75+0.10
40Ω–400Ω	0Ω–400.0Ω	24.4 mΩ	0.5 mA	4.4 ms	0.75+0.01
400Ω–4000Ω	0Ω–4000Ω	0.244Ω	50 μA	4.4 ms	0.5+0.01
4 kΩ–40 kΩ	0 kΩ–40.00 kΩ	2.44 Ω	5 μA	4.4 ms	0.5+0.01
40 kΩ–400 kΩ	0 kΩ–400.0 kΩ	24.4 Ω	0.5 μA	10 ms	0.5+0.2
400 kΩ–4 MΩ	0 MΩ–4 MΩ	244 Ω	0.5 μA	20 ms	5+0.1
4 MΩ–40 MΩ	0 MΩ–40.00 MΩ	2.44 kΩ	50 nA	50 ms	5+0.5

\* The first value is in percent of the measured value, the second value is in percent of the measuring range. Standard settings are marked in grey.

Selected speed: **medium**

Meas.Range	Full Scale	Resolution	Meas.Current	Meas.Time	Accuracy %*
0Ω–4Ω	0Ω–4.000Ω	244 μΩ	50 mA	25 ms	0.65+0.3
4Ω–40Ω	0Ω–40.00Ω	2.44 mΩ	5 mA	25 ms	0.65+0.03
40Ω–400Ω	0Ω–400.0Ω	24.4 mΩ	0.5 mA	25 ms	0.65+0.01
400Ω–4000Ω	0Ω–4000Ω	0.244Ω	50 μA	25 ms	0.4+0.01
4 kΩ–40 kΩ	0 kΩ–40.00 kΩ	2.44 Ω	5 μA	25 ms	0.4+0.01
40 kΩ–400 kΩ	0 kΩ–400.0 kΩ	24.4 Ω	0.5 μA	30 ms	0.6+0.01
400 kΩ–4 MΩ	0 MΩ–4 MΩ	244 Ω	0.5 μA	40 ms	1.0+0.01
4 MΩ–40 MΩ	0 MΩ–40.00 MΩ	2.44 kΩ	50 nA	150 ms	1.5+0.2

\* The first value is in percent of the measured value, the second value is in percent of the measuring range. Standard settings are marked in grey.

Selected speed: **slow**

Meas.Range	Full Scale	Resolution	Meas.Current	Meas.Time	Accuracy %*
0Ω–4Ω	0Ω–4.000Ω	244 μΩ	50 mA	205 ms	0.5+0.03
4Ω–40Ω	0Ω–40.00Ω	2.44 mΩ	5 mA	205 ms	0.5+0.01
40Ω–400Ω	0Ω–400.0Ω	24.4 mΩ	0.5 mA	205 ms	0.5+0.01
400Ω–4000Ω	0Ω–4000Ω	0.244Ω	50 μA	205 ms	0.3+0.01
4 kΩ–40 kΩ	0 kΩ–40.00 kΩ	2.44 Ω	5 μA	205 ms	0.3+0.01
40 kΩ–400 kΩ	0 kΩ–400.0 kΩ	24.4 Ω	0.5 μA	210 ms	0.5+0.01
400 kΩ–4 MΩ	0 MΩ–4 MΩ	244 Ω	0.5 μA	220 ms	0.5+0.01
4 MΩ–40 MΩ	0 MΩ–40.00 MΩ	2.44 kΩ	50 nA	480 ms	0.75+0.01

\* The first value is in percent of the measured value, the second value is in percent of the measuring range.

## C-Measurement

We use two different measuring methods for measuring capacitance:

- In C measurements from 1 pF to 10  $\mu$ F we use highly constant, symmetrical sine wave signals with a peak to peak voltage of 400 mV.

**Method C-Measurement:** Via a series resistor, a sine signal is applied to the capacitor to be tested. The AC-voltage drop at the capacitor is measured and evaluated. Depending on the desired value you enter, the test system automatically selects the measuring frequency.

Selected speed: **fast**

Meas.Range	Frequency	Ser.Resist.	Voltage max.	Meas.Time	Tolerance %
1 pF–1 nF	90.5 kHz	1 k $\Omega$	400 mVpp	18 ms	1.5+1
1 nF–10 nF	50.5 kHz	1 k $\Omega$	400 mVpp	18 ms	1.5+0.2
10 nF–100 nF	10 kHz	1 k $\Omega$	400 mVpp	18 ms	1.5+0.2
100 nF–1 $\mu$ F	1 kHz	1 k $\Omega$	400 mVpp	18 ms	1.5+0.2
1 $\mu$ F–10 $\mu$ F	100 Hz	1 k $\Omega$	400 mVpp	35 ms	1.5+0.2

Selected speed: **medium**

Meas.Range	Frequency	Ser.Resist.	Voltage max.	Meas.Time	Tolerance %
1 pF–1 nF	90.5 kHz	1 k $\Omega$	400 mVpp	21 ms	1.5+1
1 nF–10 nF	50.5 kHz	1 k $\Omega$	400 mVpp	26 ms	1.5+0.2
10 nF–100 nF	10 kHz	1 k $\Omega$	400 mVpp	26 ms	1.5+0.2
100 nF–1 $\mu$ F	1 kHz	1 k $\Omega$	400 mVpp	26 ms	1.5+0.2
1 $\mu$ F–10 $\mu$ F	100 Hz	1 k $\Omega$	400 mVpp	51 ms	1.5+0.2

\* The first value is in percent of the measured value, the second value is in percent of the measuring range.

- The second measuring method (current-pulse principle) covers the range 10  $\mu$ F to 10 mF.

**Method:** To start with the capacitor to be tested is discharged so that any residual charge does not affect the measured value. Using a precision current pulse of 50  $\mu$ A, 0.5 mA or 5 mA the capacitor to be tested is charged for a fixed time of 30 ms. To evaluate the capacitance, the voltage at the capacitor is measured and the computer then calculates the capacitance. After the measurement, the measuring unit discharges the capacitance to 0 V.

Selected speed: **fast**

Meas.Range	Precision Current	Voltage max.	Meas.Time *	Tolerance %
10 $\mu$ sF–100 $\mu$ F	50 $\mu$ A	650 mV	46 ms	3+0.1
100 $\mu$ F–1 mF	0.5 mA	650 mV	51 ms	3+0.1
1 mF–10 mF	5 mA	650 mV	182 ms	3+0.1

Selected speed: **standard**

Meas.Range	Precision Current	Voltage max.	Meas.Time *	Tolerance %
10 $\mu$ sF–100 $\mu$ F	50 $\mu$ A	650 mV	75 ms	3+0.1
100 $\mu$ F–1 mF	0.5 mA	650 mV	85 ms	3+0.1
1 mF–10 mF	5 mA	650 mV	125 ms	3+0.1

\* In order to reach this measuring time, the capacitor must be discharged before the measurement.

Tolerance: The first value is in percent of the measured value, the second value is in percent of the measuring range.

### Diode Measurement

No-load voltage in Zener diode measurement can be programmed as needed from 0–28 V with 14 mV resolution. In diode measurement, no-load voltage is set to 2 V.

**Method:** A programmable constant current is applied to the diode to be tested and parallel to that the threshold voltage or the zener voltage is measured. Diodes can also be measured in a four-terminal measurement.

	Meas.Time	Current	Voltage max.
D Diodes	5.5 ms	100 $\mu$ A–1mA–10 mA–100 mA	2 V
Z Diodes (<10 V) Z Diodes (>10 V)	17 ms 20 ms	100 $\mu$ A–1mA–10 mA–100 mA	28 V
ZM Measurement	5 ms	100 $\mu$ A–1mA–10 mA–100 mA	10 V

In all ranges, the accuracy of the measuring current is 2%.

### Transistor Measurement

**Method:** Transistor measurement checks if a transistor connects through. The required basic signal can be programmed in voltage from 0 to 10 V and in current in steps 50  $\mu$ A, 500  $\mu$ A, 5 mA and 50 mA. The same voltages and currents are available for the collector signal. Current accuracy is 2%. A collector-emitter voltage is measured and evaluated. There are measuring modes for NPN, PNP and JFet. By selecting the basis and collector voltage, the respective MOSFET-types can be tested with the NPN and PNP measuring modes. Measuring time is 5.5 ms.

### Inductance Measurement

**Method:** Extremely constant symmetrical sinewave signals with a peak to peak voltage of 400 mV are used for measuring coils from 4  $\mu$ H to 2 H. One of the sinewave signals is applied to the coil to be tested via a series resistor. The AC-voltage drop at the series resistor and at the coil under test is measured and evaluated. The inductance is calculated from the two measured values, the constant input voltage, the frequency and the series resistor. Depending on the desired value you enter, the measuring frequency is automatically set by the test system.

Meas.Range	Min. Quality	Ser.Resist.	Frequency	Meas.Time	Tolerance %
4 $\mu$ H–40 $\mu$ H	1	10 $\Omega$	50 kHz	115 ms	5 + 0.5
40 $\mu$ H–400 $\mu$ H	1	100 $\Omega$	50 kHz	115 ms	5 + 0.5
400 $\mu$ H–4 mH	2	100 $\Omega$	10 kHz	115 ms	4 + 0.1
4 mH–40 mH	2	1 k $\Omega$	10 kHz	115 ms	4 + 0.1
40 mH–400 mH	1	1 k $\Omega$	1 kHz	125 ms	4 + 0.1
400 mH–2 H	2	1 k $\Omega$	100 Hz	125 ms	4 + 0.1

Tolerance: The first value is in percent of the measured value, the second value is in percent of the measuring range.

### Impedance Measurement IM

**Method:** We use the same measuring method as in L-measurement. The only difference is that the frequency and the series resistance can be programmed. The measuring result is given in  $\Omega$ .

Frequency	Voltage	Series Resistance	Meas.Time
40 Hz–500 Hz	400 mV	10 $\Omega$ , 100 $\Omega$ , 1 k $\Omega$	115 ms
500 Hz–50 kHz	400 mV	10 $\Omega$ , 100 $\Omega$ , 1 k $\Omega$	900 ms

### Guarding

You can guard in the In-circuit measuring ranges R, C, L, D, Z and IM. 8 Guard channels can be closed per test step. Max. Guard current is limited at ca. 120 mA.

### Measuring Polarity

**CP-measurement** measures polarity of Elcaps, **CA-measurement** measures capacitive coupling. Both measuring ranges are optional and only work with the necessary hardware.

**Method:** Ground or a sine signal 141 mV, 5 Hz ... 1 kHz) resp. are alternatingly applied to the polarised capacitor. A capacitive probe measures the coupling (signal strength) on the capacitor housing. The small signal is amplified by a selective amplifier. Then the amplitude of the signal is evaluated by applying the signal alternatingly. There is an obvious difference between a minus and a plus signal. (The signal is obviously higher at minus-application than at plus-application.)

Measuring time up to 200 Hz is 200 ms plus a period of the set frequency. Above 200 Hz, measuring time is 15 ms plus twice a period.

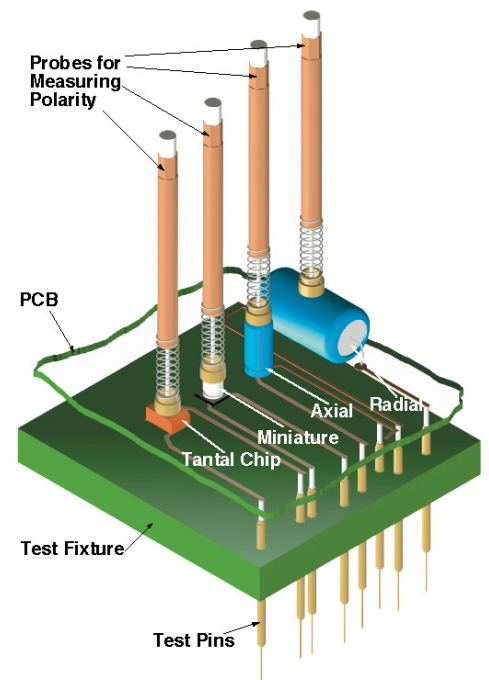

### Measuring an Operational Amplifier

**Method:** PSU1 generates the supply voltage for the operational amplifier OPV. This voltage is applied to the test item via a stimulus matrix channel. Via two RMX-channels the output is connected to the inverting input of the operational amplifier. So the operational amplifier is used as buffer. At the non-inverting input a DC-voltage is applied which can be programmed from 0 to 10 V with a current limitation from 0 to 100 mA. The output voltage of the operational amplifier is measured and evaluated. With a good operational amplifier, the output voltage must be identical with that of the programmed input voltage.



### Thyristor Measurement

**Method:** A constant current is applied to the thyristors to be tested. Maximum voltage of the current source is 3 V. First there is a check if the thyristor has turned on. If the anode-cathode-voltage drops below 2.8 V in this measurement, the measuring result is "Fail". Then a drive voltage is applied to the gate. The anode-cathode voltage is measured now and displayed in the measuring window. The anode-cathode current can be programmed from 1 to 100 mA.

You can choose between measuring modes P-Gate, N-Gate and Triac.

### Relay Measurement

**Method:** In relay measurement the resistance of a closed relay contact is measured and evaluated. It also tests if a relay switches. The control voltage of the relay can be programmed from 0 V to 27 V and the current from 0 mA to 100 mA. The measuring current for capturing the closed relay contact is always 50 mA. The measuring range goes to 25  $\Omega$  (max. measuring voltage 1.25 V). There is a four-terminal measurement for capturing the exact resistance. A measuring voltage of 3.5 V is used for checking if the relay contact is always closed (sealed). If the resistance value of the open relay contact drops below 31.5  $\Omega$ , the measuring result is "short". You can choose between relays with normally open or normally closed contacts.

### Opto-coupler Measurement

**Method:** The collector-emitter-voltage is evaluated with a controlled opto-coupler. The LED-drive voltage can be programmed from 0 V to 27 V and the current from 0.1 mA to 100 mA. There is also a check, if the output transistor is high-resistive when the LED is not driven. The high resistance check is made with a voltage of 3 V. If this voltage drops below 2.7 V without drive, the measuring result is "Fail".



## Function Test

### UDC

The input voltage is amplified by a potential-free pre-amplifier with 7 measuring ranges and digitized via a 16 bit AD-converter. You can choose from three measuring speeds. Under "fast" speed, the AD-converter only measures. The measuring time therefore is only 1.5 ms. Under "medium" speed the measurement is executed for 20 ms, in "slow" speed it is executed for 200 ms and an average is taken. For the UDC-measurement, there is also a trigger drive so that the measurement can start pointedly. You can also set a delay between trigger and start of the measurement. You can trigger to positive and negative edges. Trigger levels reach from -30 to +30 V. The trigger signal is transmitted to the measuring unit via the guard bus.

Meas.Range	Full Scale	Input Resistance	Resolution	Accuracy %
100 mV	-100 mV to +100 mV	$10^{13} \Omega$	$3 \mu\text{V}$	0.1 + 0.07
400 mV	-400 mV to +400 mV	$10^{13} \Omega$	$12 \mu\text{V}$	0.06 + 0.03
1 V	-1 V to +1 V	$10^{13} \Omega$	$30 \mu\text{V}$	0.05 + 0.02
4 V	-4 V to +4 V	$10^{13} \Omega$	0.12 mV	0.05 + 0.01
10 V	-10 V to +10 V	10 M $\Omega$	0.3 mV	0.05 + 0.015
40 V	-40 V to +40 V	10 M $\Omega$	1.2 mV	0.05 + 0.005
100 V	-100 V to +100 V	10 M $\Omega$	3 mV	0.05 + 0.005

### IDC

DC current measurement is a voltage measurement. The operator must place a measuring transformer (shunt, current transducer) in the test fixture. The only difference between UDC and IDC-measurement is that in current measurement the measured value is edited in "A".

### UAC

The input signal is prepared by a potential-free pre-amplifier. The output signal of the amplifier feeds a TrueRMS-converter. Frequency ranges from 45 Hz to 300 kHz. Again, you can choose from three measuring speeds. "medium" and "slow" can measure frequencies higher than 45 Hz. The only difference between the the two speed levels lies between turning on the signal and starting the AD-converter. Speed "fast" is for frequencies above 750 Hz.

Meas.Range	Resolution	Input Resistance	Accuracy % 45 Hz–20 kHz	Accuracy % 20 kHz–100 kHz	Accuracy % 100 kHz–300 kHz
70 mV	$3 \mu\text{V}$	1.1 M $\Omega$	0.4 ± 0.2	0.7 ± 0.4	5 ± 0.6
300 mV	$12.2 \mu\text{V}$	1.1 M $\Omega$	0.35 ± 0.1	0.7 ± 0.2	5 ± 0.6
700 mV	$30 \mu\text{V}$	1.1 M $\Omega$	0.35 ± 0.05	0.7 ± 0.1	5 ± 0.6
3 V	0.12 mV	1.1 M $\Omega$	0.35 ± 0.025	0.7 ± 0.1	5 ± 0.6
7 V	0.3 mV	1 M $\Omega$	0.35 ± 0.025	0.7 ± 0.1	5 ± 0.6
30 V	1.22 mV	1 M $\Omega$	0.35 ± 0.025	0.7 ± 0.1	5 ± 0.6
70 V	3 mV	1 M $\Omega$	0.35 ± 0.025	0.7 ± 0.1	5 ± 0.6

The table refers to "medium" and "slow" speeds.

Measuring times: fast 40 ms, medium 440 ms, slow 840 ms

Max. Crest factor is 7.

**IAC**

AC current measurement is a voltage measurement. The operator must place a measuring transformer (shunt, current transducer) in the test fixture. The only difference between UAC and IAC-measurement is that in current measurement the measured value is edited in "A".

**You can expand ATS-MFT 770 with a 7½ position digital voltmeter (option).** The digital voltmeter is comfortably addressed via the system software. You can then use the following measuring ranges:

**PUDC**

DC voltage measurement is in 5 ranges.  
(Tolerances are valid in a calibration cycle of 1 year and 23 °C +/-5).

Meas.Range	Resolution	Input Resistance	Accuracy ppm
100.0000 mV	10 nV	>10.000 GΩ	37 ppm + 9
1.0000000 V	100 nV	>10.000 GΩ	25 ppm + 2
10.000000 V	1 μV	>10.000 GΩ	24 ppm + 4
100.00000 V	10 μV	10.000 MΩ	35 ppm + 5
1000.0000 V	10 μV	10.000 MΩ ± 1 %	41 ppm + 6

**PIDC**

DC current measurement is in 4 ranges.  
(Tolerances are valid in a calibration cycle of 1 year and 23 °C +/-5).

Meas.Range	Resolution	Accuracy %
10.000000 mA	1 nA	500 ppm + 40
100.00000 mA	10 nA	500 ppm + 40
1000.0000 mA	100 nA	800 ppm + 40
3.000000 mA	1 μA	1200 ppm + 15

**PUAC**

AC voltage measurement (TRUE RMS) is in 5 ranges, accuracy is +/- (% of the measured value + % of the measuring range), 23 °C +/-5 °C

Meas.Range	Resolution	Calibration Cycle	Accuracy % 10 Hz–20 kHz	Accuracy % 20 kHz–50 kHz	Accuracy % 50 kHz–100 kHz
100.000 mV	0.1 μV	90 Days	0.05+0.03	0.11+0.05	0.60+0.08
1.000000 V	1 μV	90 Days	0.05+0.03	0.11+0.05	0.60+0.08
10.00000 V	10 μV	1 Year	0.06+0.03	0.12+0.05	0.60+0.08
100.0000 V	10 μV	1 Year	0.06+0.03	0.12+0.05	0.60+0.08
750.000 V	1 mV	1 Year	0.06+0.03	0.12+0.05	0.60+0.08

**PIAC**

AC current measurement is in 2 ranges (tolerances at 23 °C +/-5).

Meas.Range	Resolution	Calibration Cycle	Accuracy % 3 Hz–10 Hz	Accuracy % 10 Hz–5 kHz
1.000000 A	1.0 μA	90 Days	0.30+0.04	0.10+0.04
3.00000 A	10 μA	90 Days	0.35+0.06	0.15+0.06

**PR**

R measurement is with the system multimeter in 8 ranges (Tolerances are valid in a calibration cycle of 1 year and 23°C +/-5).

Meas.Range	Resolution	Meas.Current	Accuracy ppm
10.000000Ω	1 μΩ	10 mA	60 ppm +9
100.00000Ω	10 μΩ	1 mA	52 ppm +9
1.0000000kΩ	100 μΩ	1 mA	50 ppm +2
10.000000kΩ	1 mΩ	100 μA	50 ppm +2
100.00000kΩ	10 mΩ	10 μA	70 ppm +2
1.0000000MΩ	100 mΩ	10 μA	70 ppm +4
10.000000MΩ	1 Ω	640 nA	400 ppm +4
100.00000MΩ	10 Ω	640 nA	1500 ppm +4

With the exception of four-terminal measurement, because of contacts, relay contacts and lines, there is a series resistance in these ranges. These tolerances are only valid in function test.

**PK**

In the analog Peak measurement, there is a Sample&Hold circuit between pre-amplifier and AD-converter where the highest and lowest values are saved.

Meas.Range	Accuracy % 0 Hz–20 kHz	Accuracy % 20 kHz–75 kHz
400 mV	1.0 ±0.75	5.0 ±0.75
1 V	1.0 ±0.75	5.0 ±0.75
4 V	1.0 ±0.75	5.0 ±0.75
10 V	1.0 ±0.75	5.0 ±0.75
40 V	1.0 ±0.75	5.0 ±0.75
100 V	1.0 ±0.75	5.0 ±0.75

There is also a digital Peak-measurement. In digital Peak-measurement, the measuring signal is scanned with 100kHz at a measuring time up to 40.96 ms. At a measuring time longer than 40.96 ms, it is scanned with 10kHz. The system then displays the highest or lowest measuring value.

**Time measuring system, clock rate 20MHz, 31 bit counter**

The start- and stop level can be programmed in the range -30V to +30V with 15 mV resolution. For UDC-measurement, there is also trigger drive so that the measurement can start pointedly. You can trigger to positive and negative edges. Trigger levels may reach from -30V to +30V. The trigger signal is transmitted to the measuring unit via the guard bus. The ZME also includes a hold-off-function which allows max. 163.84 ms hold-off period. In this case, min. hold-off resolution is 50 ns.

	Range	Resolution
High Frequency	25 mHz	5 Hz
Low Frequency/Period	200 kHz	50 ns
Pos. Pulse Width	2 mHz	50 ns
Neg. Pulse Width	2 mHz	50 ns
Rise Time	2 mHz	50 ns
Fall Time	2 mHz	50 ns
Run Time ++	2 mHz	50 ns
Run Time +-	2 mHz	50 ns
Run Time -+	2 mHz	50 ns
Run Time --	2 mHz	50 ns
Events	1 bit	
Pulse Ratio		50 ns
Precision-HF	25 mHz	1 Hz
Phase Shift	360 °	0.1 °

**Monitor Measurement**

Monitor measurement measures the integrated stimulus devices (PSUs, generator, fixed voltages, etc.) with the advantage that no special wiring is required by the operator. The output currents of the stimulus devices can also be measured directly.

**TRA ADM-Measurement**

The "TRA ADM"-measurement is equivalent with the "TRA A"-measurement. Potential-free measurements are also available. For external triggering the trigger signal is applied at the guardbus.

Timebase	Meas. Frequency	Number Meas. Points
10 $\mu$ s	100 kHz	10
20 $\mu$ s	100 kHz	20
50 $\mu$ s	100 kHz	50
100 $\mu$ s	100 kHz	100
200 $\mu$ s	100 kHz	200
500 $\mu$ s	100 kHz	500
1 ms	100 kHz	1000
2 ms	100 kHz	2000
5 ms	10 kHz	500
10 ms	10 kHz	1000
20 ms	10 kHz	2000
50 ms	10 kHz	4096

**TRA670 Transient Recorder**

The optional TRA670 provides a high frequency amplifier (50 MHz). AD-converter and a very fast AD-converter (250 MSPS). The measuring signal can be applied via the RMX-channels, 9 external channels or 8 coaxial channels. Bandwidth and measuring ranges are independent of the used measuring system. With frequencies above 1 MHz it makes sense to use the coaxial channels.

The following ranges are for evaluating the recorded signal (evaluation is a calculation from the recorded curves):

NoMess	There is no evaluation
MinPk	negative peak voltage measurement
MaxPk	positive peak voltage measurement
Pk-Pk	peak-peak-voltage measurement
Frequency	frequency measurement
Pos.P	pulse width positive
Pos.P	pulse width negative
Rise	rise time measurement
Fall	fall time measurement
Envelope	envelope curve-comparison measurement, programmable in time and voltage axis
Key	for manual interpretation by the operator
Mean	average value of the signal
RMS	effective value of the signal
Distortion	evaluation of the distortion factor

Range	Full Scale	Resolution	Accuracy
200 V	-200 V to +200 V	50 mV	1 % ±4 Digits
80 V	-80 V to +80 V	20 mV	1 % ±4 Digits
20 V	-20 V to +20 V	5 mV	1 % ±4 Digits
8 V	-8 V to +8 V	2 mV	1 % ±4 Digits
2 V	-2 V to +2 V	500 $\mu$ V	1 % ±4 Digits
0.8 V	-0.8 V to +0.8 V	200 $\mu$ V	1 % ±4 Digits

Max. frequency: 50 MHz  
 Resolution: 12 Bit  
 Clock rates: 250 MSPS  
 Input resistance: 50  $\Omega$ /1 M $\Omega$

The basic version of ATS-MFT 770 has got 4 programmable voltage supplies and 5 fixed voltages. The tolerances given depend on the programmed value, adjusted to ADM and without load.

	Voltage	Resolution	I max.	Tolerances
PSU 1 positive	0V to +38V	1 mV	2 A up to + 15V 1 A > +15V	0.1 % ±10 mV
PSU 1 negative	0V to -38V	1 mV	1 A	0.1 % ±10 mV
PSU 2 positive	0V to +38V	1 mV	2 A up to + 15V 1 A > +15V	0.1 % ±10 mV
PSU 2 negative	0V to -38V	1 mV	1 A	0.1 % ±10 mV

Fixed voltage supplies +5.2, -5, +15, -15, +40 and -40 V with 500 mA max. current

#### MNG-PSUs ATS-MFT 770

The MNG1 and MNG2 PSUs are on the MMX670 of the basic version, further MNG-PSUs can be expanded with optional additional MMX670-boards.

MNG	Voltage	U-Resolution	U-Tolerance	Current	I-Resolution	I-Tolerance
MNG 1	0V to +38V	1 mV	0.01 %±5 mV	30–500 mA	10 µA	0.1 % ±1 mA
MNG 2	0V to +38V	1 mV	0.01 %±5 mV	30–500 mA	10 µA	0.1 % ±1 mA
	0V to -38V	1 mV	0.01 %±5 mV	30–500 mA	10 µA	0.1 % ±1 mA

#### Optional Additional PSU NGS670

(The tolerances given have been found without load.)

	Voltage	Resolution	I max.	Resolution	U Tolerance	I Tolerance
PSU 3	0V to +8.191 V	2 mV	4 A	1 mA	0.1 % ±2 mV	0.75 % ±5 mA
PSU 4	0V to +38V	10 mV	1 A	0.25 mA	0.1 % ±10 mV	1 % ±2.5 mA
PSU 5	0V to -38V	10 mV	1 A	0.25 mA	0.1 % ±10 mV	1 % ±2.5 mA

#### Optional potentialfree PSU ENG-60V

Range	I max.	Tolerances
2* -15V/+15V	200 mA	2.50 %
2* 2–26V	200 mA	2.50 %



### ZNG Potential-free PSU on the ZDC100 Zener Diode Measuring Board

Potential-free PSU	
Max. voltage	25 V, accuracy 2%
Max. current	1 A, accuracy 5%
Resolution voltage	0.5 mV
Resolution current	40 $\mu$ V
Max. ripple bandwidth 20 MHz	150 mV <sub>pp</sub>
Slew rate	6 $\mu$ s/V
Isolation voltage	500 V
Isolation resistance	100 M $\Omega$
Isolation capacitance	20 nF

### Programmable Potentialfree Electronic Load

The programmable electronic load has a resolution of 16 Bit and can be modulated between 10 Hz to 10 kHz. Pulse duty factor can be programmed between 5 and 95 %. OVP (overvoltage protection) is programmed from 5 V to 100 V in 100 mV steps.

Current max.	Resolution	Voltage max.	Power max.	Accuracy
5.1 A	0.1 mA	90 V	65 W	0.5 % $\pm$ 5 mA

### Optional 4Fold Load LA670

There are 4 potential-free loads each of which can be programmed independent from the others.

Current max.	Resolution	Voltage max.	Power max.	Accuracy
4.096 A	1 mA	60 V	60 W	0.25 % $\pm$ 5 mA

### Optional AC-Source AC670

Frequency ranges from 25 Hz to 6.553 kHz, resolution is 0.1 Hz.

Range	Current max.	Resol. I	Resol. U	U Tolerance	I Tolerance	Power max.
0 V–30 V	1 A	0.24 mA	10 mV	0.5 % $\pm$ 200 mV	5 % $\pm$ 18 mA	30 W
30 V–140 V	0.3 A	0.24 mA	50 mV	0.5 % $\pm$ 200 mV	5 % $\pm$ 18 mA	42 W
140 V–280 V	0.15 A	0.24 mA	100 mV	0.5 % $\pm$ 200 mV	5 % $\pm$ 18 mA	42 W

The AC670 Source also holds a DC-source:

Range	max. Current	Resol. I	Resol. U	U Tolerance	I Tolerance	Max. Power
0 V–350 V	100 mA	0.24 $\mu$ A	100 mV	0.1 % $\pm$ 200 mV	1 % $\pm$ 1 mA	35 W

The AC670 source can either be used as AC-source or as a DC-source.

### Standard Sine and Square Wave Generator ATS-MFT 770

Output frequency can be programmed from 0 Hz to 1 MHz. The 3db limit of the square wave output is 500 kHz, that of sine is 250 kHz. Voltage, frequency and current can be monitored and recalibrated with the internal measuring unit by software. The 1 A max. current can be programmed in 100  $\mu$ A-steps with 5 %  $\pm$ 50 mA tolerance for the sine output and with 10 %  $\pm$ 50 mA for the square wave output. Pulse duty factor of the square wave output can be programmed from 10–90 %. The offset voltage can be programmed from -25 V to +25 V with 10 mV resolution.

	Resolution F	Frequency	max. Ampl.	Resolution U	Current	U Tolerance
Generator Sine	100 mHz	0 Hz–250 kHz	25 V <sub>eff</sub>	1 mV	1,0 A	0.1 % $\pm$ 50 mV
Generator Square Wave	100 mHz	0 Hz–500 kHz	25 V <sub>pk</sub>	1 mV	1,0 A	0.1 % $\pm$ 50 mV

### 20 MHz Function arbitrary generator:

Sine, square wave, triangle, sawtooth, noise, impulse, arbitrary functions, burst, wobble. There are frequencies from 1  $\mu$ Hz to 20 MHz with resolutions from 1  $\mu$ Hz. Amplitudes can be programmed between 20 mVpp up to 20 Vpp. Ramps can be programmed up to 200 kHz with 20 ppm accuracy. Maximum frequencies in the burst range is 5 MHz. Trigger can be done single, external or internal.

	Resol.	Frequ. min.	Frequ. max.	Ampl. max.	U Tolerance	F Accuracy
Generator Sine	1.0 $\mu$ Hz	1.0 $\mu$ Hz	20 MHz	10 Vpp	1 % 1 kHz	20 ppm
Generator Square	1.0 $\mu$ Hz	1.0 $\mu$ Hz	20 MHz	10 Vpp	1 % 1 kHz	20 ppm
Generator Triangle/ Sawtooth	1.0 $\mu$ Hz	1.0 $\mu$ Hz	20 MHz	10 Vpp	1 % 1 kHz	20 ppm
Generator Pulse	20 ns	500.0 $\mu$ Hz	5 MHz	10 Vpp	1 % 1 kHz	20 ppm
Generator Arbitrary	20 ns	1.0 $\mu$ Hz	6 MHz	10 Vpp	1 % 1 kHz	20 ppm

### 80 MHz Function arbitrary generator:

Sine, square wave, triangle, sawtooth, noise, impulse, arbitrary functions, burst, wobble. There are frequencies from 1  $\mu$ Hz to 80 MHz with resolutions from 1  $\mu$ Hz. Amplitudes can be programmed between 10 mVpp up to 10 Vpp. Ramps can be programmed up to 1 MHz with 3 ppm accuracy. Maximum frequencies in the burst range is 80 MHz. Trigger can be done single, external or internal.

	Resol.	Frequ. min.	Frequ. max.	Ampl. max.	U Tolerance	F Accuracy
Generator Sine	1.0 $\mu$ Hz	1.0 $\mu$ Hz	80 MHz	10 Vpp	1 % 1 kHz	3 ppm
Generator Square	1.0 $\mu$ Hz	1.0 $\mu$ Hz	80 MHz	10 Vpp	1 % 1 kHz	3 ppm
Generator Pulse	8 ns	500.0 $\mu$ Hz	50 MHz	10 Vpp	1 % 1 kHz	3 ppm
Generator Arbitrary	20 ns	1.0 $\mu$ Hz	25 MHz	10 Vpp	1 % 1 kHz	3 ppm

### RMX Measuring matrix

Service life	250 x 10 <sup>6</sup> switching operations
Contact resistance	0.1 $\Omega$ per relay contact
Max. current	0.5 A
Max. voltage	100 V
Max. contact rating	10 VA
Coil resistance	500 $\Omega$

\* Mechanically there are a lot more than 250 x 10<sup>6</sup> switching operations – contact resistance will then be out of the specifications.

**Measuring-Logic-Stimulus Matrix Board RML32 – Stimulus Matrix**

	AC	DC
Max. breaking voltage	100 V <sub>pk</sub> /70 V <sub>eff</sub>	100 V
Max. r.m.s current	2 A	2 A
Max. breaking capacity at 30 V	60 VA	60 W
Max. breaking capacity at 70 V	140 VA	90 W
Max. breaking capacity at 100 V	–	90 W

**RML32-Board – Logic**

Driver level	3.3 V / 5 V
Max. driver current	15 mA
Max. input voltage	5 V
Rise/Fall Time	500 ns

**VMX8 High-voltage measuring matrix**

High-voltage Measuring Channels VMX 8	AC	DC
Max. input voltage	420 V <sub>pk</sub>	420 V
Accuracy	0.5%+0.1	0.5%+0.1
Frequency range	0 Hz–400 Hz	
Input resistance	10 M $\Omega$	10 M $\Omega$
Division factor	50	50

**ZDC100 Zener Diode Measuring Board 100 V**

Voltage Source	
Current ranges	0.1 mA, 1 mA, 5 mA, 10 mA
Voltage ranges	0–50 V, 0–75 V, 0–100 V
Discharge Source	
Current range	0–100 mA
Voltage range	0–100 V
Max. power	10 W

**Stimulus Matrix MMX670, MMX72 and EMX48**Insulation resistance 10<sup>9</sup>  $\Omega$ 

	AC	DC
Max. breaking voltage	100 V <sub>pk</sub> / 70 V <sub>eff</sub>	100 V
Max. r.m.s current	2 A	2 A
Max. breaking capacity at 30 V	60 VA	60 W
Max. breaking capacity at 50 V	100 VA	90 W
Max. breaking capacity at 70 V	140 VA	63 W
Max. breaking capacity at 100 V	–	50 W

**High Voltage Stimulus Matrix HSM670**

	AC	DC*
Max. voltage	250 V	250 V
Max. switching current	10 A	10 A
Max. power	2,500 VA	300 W

\* Note the contact details of the DE1A relay produced by Panasonic.

**Power Matrix PMX 16**

	AC	DC
Max. voltage	70 V <sub>eff</sub>	100 V
Max. switching current	10 A	10 A
Max. power	1,000 VA	1,000 W

**LOG96 Logic Board**

Driver level	3.3 V / 5 V
Max. driver current	15 mA
Max. input voltage	5 V
Rise/Fall Time	500 ns

**PML670 Precision Measuring Logic Board**

Driver level	0 to 30 V
Resolution	0.5 mV
Accuracy with sense connection	±2 mV
Maximum current carrying capacity per channel	50 mA
Maximum current carrying capacity all channels together	500 mA
Valid input voltage comparator	-0.7 to 30 V
Measuring range comparator	0 to 30 V
Resolution	0.5 mV
Accuracy	±4 mV

**Programmable Resistance Decade**

Range	Resol.	Max. Capacity	Activation	Accuracy
1 Ω–16.777 MΩ	1 Ω	0.5 W	potentialfree	better than 1 % +transition-R of the system*

\* Contact resistance: typically 0.5 to 5 Ω, dependent on the condition of the connectors in the test system interface

**LMX670 Power Matrix**

	AC	DC
Max. breaking voltage	300 V <sub>eff</sub> / 425 V <sub>pk</sub>	300 V
Max. r.m.s current	16 A	16 A
Max. breaking capacity at 25 V	4000 VA	400 W
Max. breaking capacity at 35 V	4000 VA	175 W
Max. breaking capacity at 50 V	4000 VA	120 W
Max. breaking capacity at 100 V	4000 VA	70 W
Max. breaking capacity at 300 V	4000 VA	70 W
<b>High-voltage measuring channels LMX670</b>		
Max. input voltage	420 V <sub>pk</sub>	420 V
Accuracy	0.5% + 0.1	0.5% + 0.1
Frequency range	0 Hz–400 Hz	
Input resistance	10 MΩ	10 MΩ
Division factor	50	50

**Technical Data and Variations of the POMO80 power module**

POMO80 is made up of PSUs and loads with arbitrary generator which can generate individual curve forms for every measuring task.

Example for order name: *POMO80/1/2*: The number second to last is for the number of DC-modules, the last number is for the number of load modules. The title of the column is the order name.

POMO	80/1/2	80/2/1	80/0/2P	80/2/0	80/1/0	80/0/4	80/0/3
<b>DC-Module</b> 0–30 V, max. 14 A, 30–65 V, max. 7 A, 65–80 V, max. 4 A, U resolution 25 mV, I resolution 4 mA	1	2	-	2	1	-	-
<b>Load Module</b> 0–30 A, 10 mA resolution, 0–3 A, 1 mA resolution, max. 400 VA to 40 V, 200 VA from 40 to 100 V, modulation I-, R- and P-mode-operation, modulation up to 50 kHz	2	1	2	-	-	4	3
<b>Load Module P</b> 0–40 A, 10 mA resolution, 0–3 A, 1 mA resolution, max. 400 VA to 40 V, 200 VA from 40 to 100 V, modulation I-, R- and P-mode-operation, modulation up to 50 kHz	-	-	2	-	-	-	-

Dimensions: 19", 3HU, 450 mm deep, weight 25 kg

can be provided as a 19" desktop-unit or a 19" built-in unit (please advise in your order)

Below you will find some examples for what a load- or DC-curve can look like so that in-rush currents of a bulb can be simulated or that a certain basic load is applied to a test item e. g. a PSU) and power peaks can be modulated.

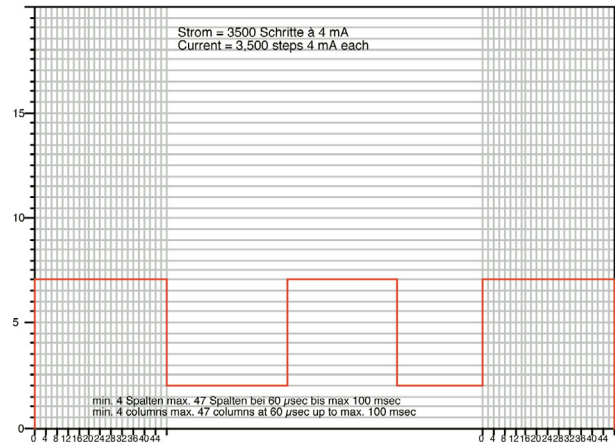
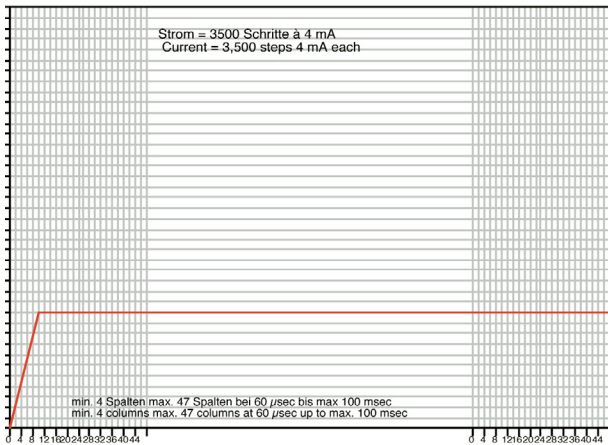
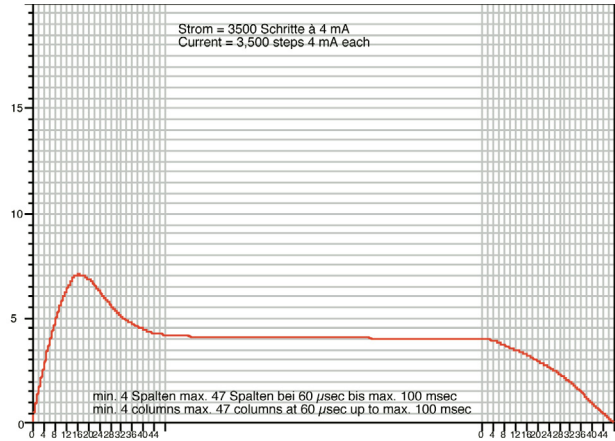
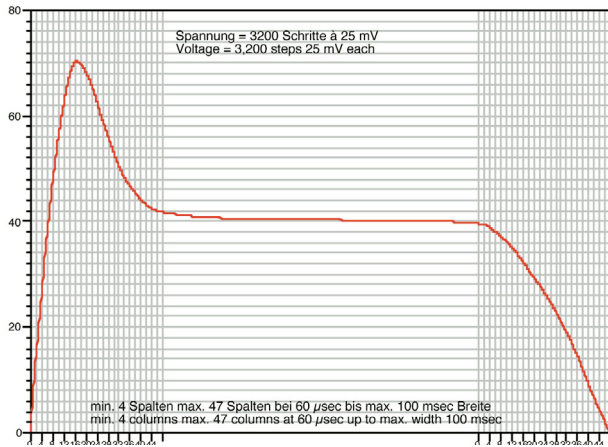

**IE & OE Specifications subject to change without prior notice.**



## Software

All our test systems are programmed in forms: As in tables and lists, only the necessary data are entered, whereas many other systems are programmed line by line. In designing software, REINHARDT always aim at enabling the user to operate the system in a comfortable, fast and productive way. A technician with basic knowledge of WINDOWS® must be able to program the test system. It must be possible to get started easily and immediately even after a longer interval. Both the tester and the programmer do not need software knowledge, they just have to apply the test item and press the start key. This is why most REINHARDT-customers use their test system in production only one week after delivery and can then produce with it. It takes only one tenth to one twentieth of the usual time to program smallest series, just in time products and middle to comprehensive products.

The forms of the software are opened and run in a logic flow. All inputs of parameters and information texts are tested syntactically when they are entered. They are only accepted when entered correctly or when the values correspond with the physical suppositions. You enter only the fourth part of the actual input, because you do not have to enter all the repetitive terms of a programming language. This is why you have to make only a fourth of the usual inputs. Because of the well-structured forms, there is highest transparency in creating a program. Therefore there is an extremely good control when the program has to be changed later: the test step and the parameter to be changed are found within seconds. All important functions are entered via mouse or cursor and function keys. Input thus becomes easy and practice-oriented even for those who are not used to typing.

## Test Program Wizard

A wizard helps generate the PCB test since the sequence of generating a test program is always very similar although the junction of different pieces of information such as CAD-data, pictures, fixtures etc. is required

The wizard is menu-driven: First it asks which test is to be executed, In-circuit- or Function test or combined. In the following steps you state if a pin test, isolation test, IC-Open test and a component test is executed. Then the data for graphical display of fault location are loaded. After that, all tasks are neatly listed again. In the next steps, the wizard guides you through all necessary programming modules so that you only have to follow its instructions. Thus, even an inexperienced user can generate a test program fast and easily.

## Test Sequence

A test program is made up of several single test modes such as e.g. pin contact test, insulation test, IC-solder defect test, components test, function test etc. In the test sequence tree on the left-hand of the screen you can see which test mode is active at the moment. This function can also be faded out.

For testing in production there is the "Testermode", where the test mode is already set, if e.g. a function test follows the components test. In the "Testermode" the monitor displays only the very necessary data so that even a trainee can operate the test system without problems and can concentrate on the essential. In this mode, the tester cannot edit. The test program cannot be changed then, i. e. the test modes cannot be turned on or off and you cannot branch off to other test modes. There are only the necessary operation keys for the tester such as e.g. Start, Stop, Fault Display ...

First you can enter a serial number which is e.g. generated via barcode scanner, entered by keyboard or automatic increment or decrement.

Pin contact tests, if all spring contact pins make contact with the PCB. In case of fault, the respective pins are displayed graphically.

The number of faults which have occurred so far in this test mode and the total of faults in this test module is displayed on screen. The analog bar displays how far the test run has proceeded.

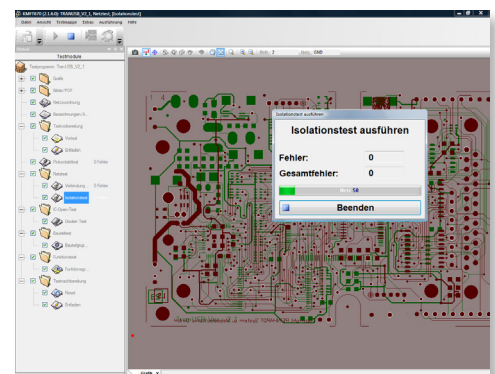
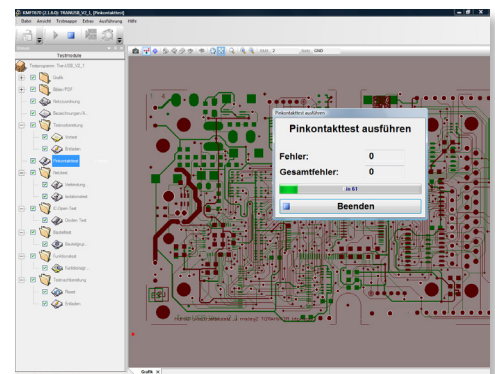
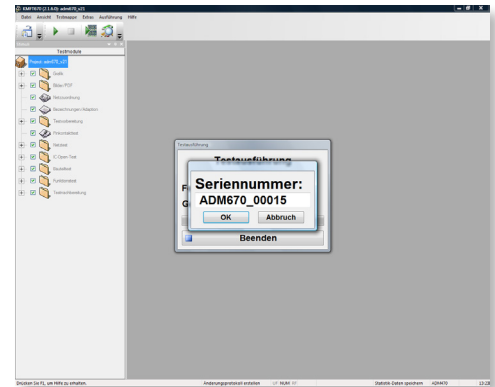

Solder short-circuits or interrupts are found and displayed in the track and insulation test.

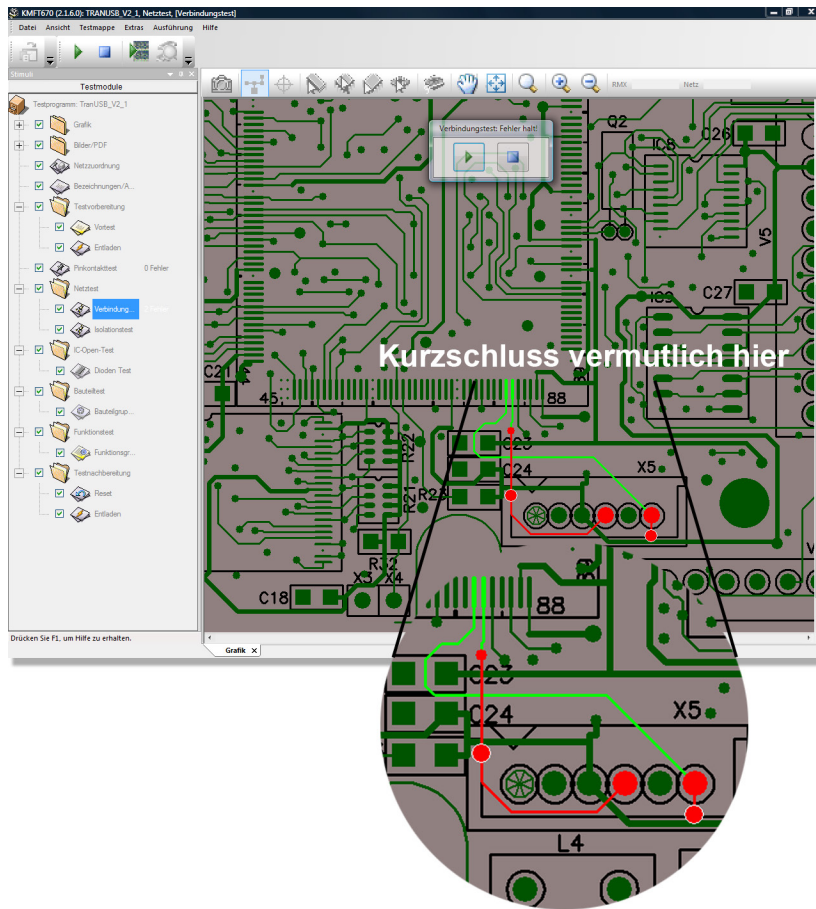

An IC-Open test follows which makes sure that the IC-pins make electric contact to the PCB. A fault has occurred on the IC which is marked in white on the

following picture. The crosshairs clearly mark the pin with the solder defect. The conductor track which is connected to this pin, is optically set off.

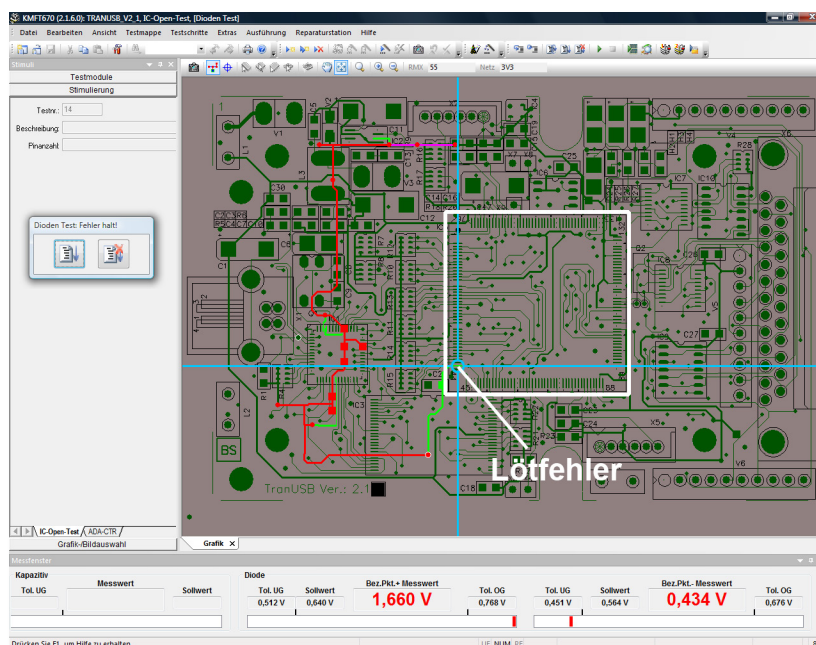

In the next test mode the components are tested: Has the correct type of component (e.g. R, FET, OPs ...) with the correct value in the correct orientation been placed in the correct position? As in our example, the graphical fault display appears which shows the defective component exactly. The connected tracks are optically set off so that you can see which other components are connected. Apart from that the window shows that the test has been finished and was faulty or OK. If you want, you can now move into the mode which displays the single faults and where you can remove them. You can remove the test item now and replace it by a new one.

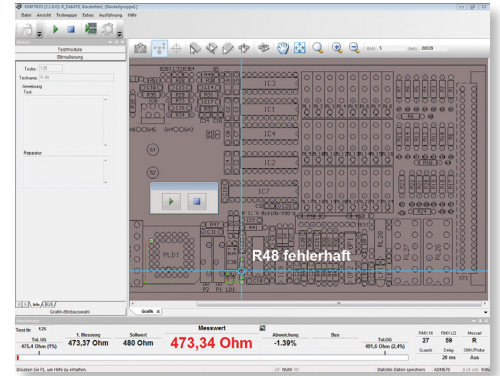

### Creating a Fixture and a Test Program

One of the most difficult tasks around automatic test systems is fixturing the test item via a needle or connector fixture and creating test programs. For this we offer special solutions which enable you to create a test fixture and test program in typically one day of work. We use the Gerber files to create the data for the drilling files and the creation of the fixture and for graphical display of fault location on screen. CAD-files for creating test programs can be transferred by post-processors and in this way, a comprehensive test program can be created in a few minutes. We are going to support all common standards in electronics production so that for programming your test system, you can use drivers of renowned producers in this field. In this way you will be able to transfer data of any CAD-system or to create and translate those of competitive test systems.

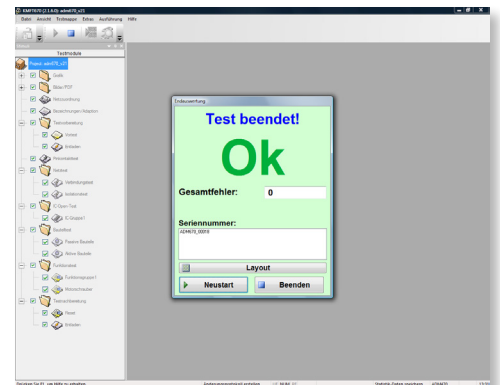

As many production areas are sluggish and the test bay is often overworked, series defects are often not found before days have passed and the test bay is forced to rework every single PCB. This affects quality and reliability and customers often do not accept this. In this case it is advantageous to test and check the assembly immediately after soldering. Max. 3–5 PCBs will be between assembly and test so that you can intervene very fast, find the faults at once and remove them.

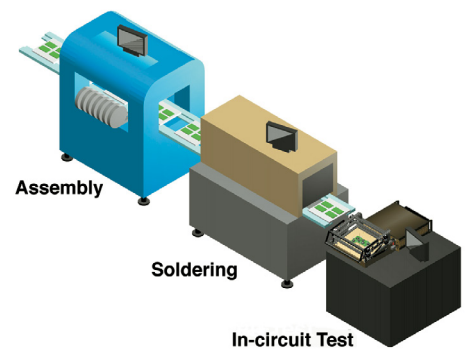

### Programming the Test System and Working with Gerber Files

Before we start explaining how to program by text and screen-pictures, we present a diagram which shows the single steps of programming. For programming we assume a typical board size of Euro-format with mixed loading, microprocessor.

**Diagram Creating a Test Program with Typical Times and a Finished Fixture**

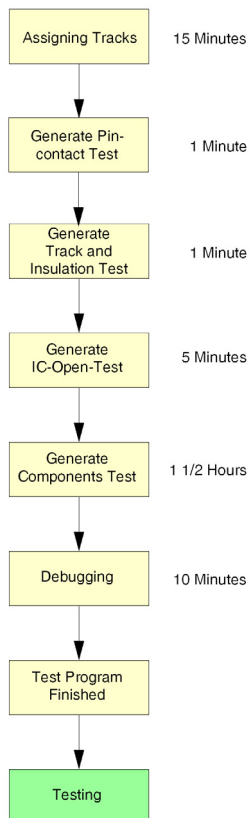

**Diagram for Building a Fixture, Graphical Display of Faults and Creating a Test Program with Typical Times**

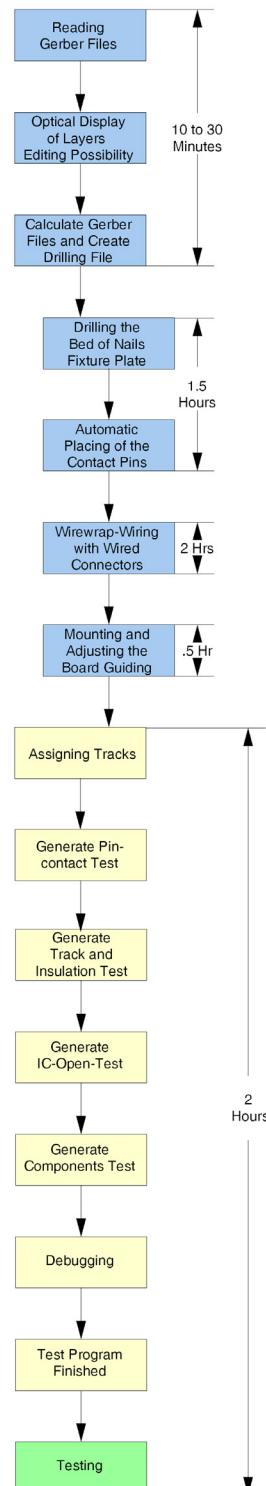



First the Gerber data of the test item are read in. We use the Gerber data for creating bed-of-nails fixtures and for graphical support in programming. This additional possibility helps our customers when the CAD-data of the developer are insufficient or unavailable.

All common CAD systems offer Gerber data, the only common standard of CAD systems. That is why we use these data which are more or less made up of single vectors. With them we calculate complete conductor tracks with the component drillings and the through-connections. The single layers (up to 255) can be graphically displayed on screen, either one after the other or all at the same time, or they can be edited if needed. Various DCodes can be extracted of the displayed layers and single layers can be reflected. When all the layers are congruent, the software starts recalculating all tracks. This process is worked out within a few seconds, even for double-Eurocards in multi-layer technique. A drilling file for the bed-of-nails is created then incl. graphical data for display on screen. For more details please see the chapter on our fixtures. The whole process for editing, displaying the PCB, creating the tracks and the drilling data takes about 10 to 30 minutes.

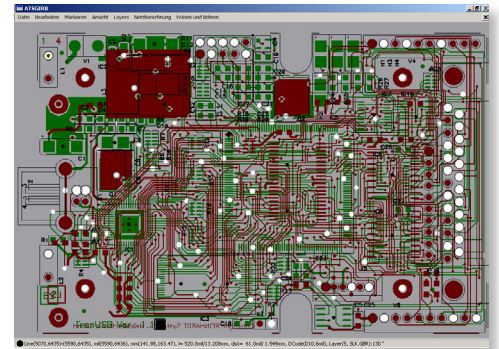

## In-circuit Test and its Programming

There are 5 editors for the in-circuit test:

Graphic data or CAD-data import

1. Assigning tracks
2. Pin contact test editor
3. Track test editor (Continuity and insulation test)
4. IC-test editor
5. Components test editor
6. The editors and procedures are described in detail on the following pages.

For creating a test program, a test file is created first with the single parts of the test program (test mode) filed in a clear way, because a test program can be made up of several parts.

Then the graphical data, which were automatically created by the ATSGERB-software (software for dealing with Gerber files), can be chosen and integrated under menu-control.

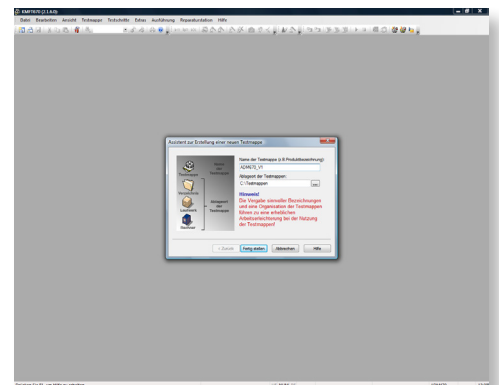

## Assigning Tracks

Assigning tracks means that the test contact pin is assigned (and this also means the track of the component) to the test system measuring channel.

With a REINHARDT-In-circuit test system you do not have to wire the bed-of-nails fixture specifically but you wire it 1 : 1. Assigning spring test contact pins to the respective test system measuring channel is comfortable via identification probe and monitor control. Because of this procedure you spend only 1/20 of the time you need for wiring your fixture specifically. Wiring mistakes, which can hardly be avoided in more complex fixtures, need not be searched and corrected.

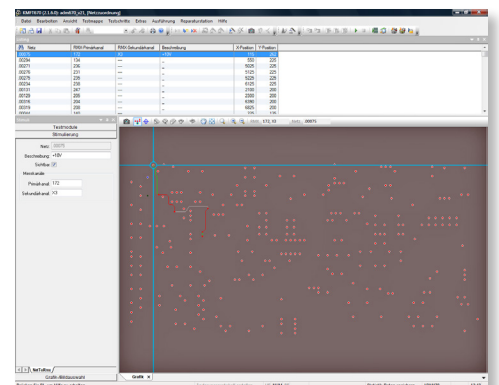



## Pin Contact Test Editor

Pin contact test finds faults in contacting the test item with the contact pins and displays them on screen. This avoids ghost and pseudo-faults. If there is no pin contact test and a contact pin does not make contact to the test item, the test system may send the message that a transistor is defective or resistor is not assembled although that is not true.

The pin contact test is learnt fully automatically. You contact your test item which is known to be good and just enter the first and the last pin number to be learnt. In about 10s to 20s all the placed pins and the pins which make contact with the test item are learnt automatically. Our method is based on a resistance and a capacitance measurement. You can call an editor where it is possible to manually change the threshold values of the automatically created program. A graphical display is also created automatically for displaying the fault location. If there is a contact fault in the test run, the defective spring test contact pin is immediately graphically displayed. In this way, even a temporary worker can find and change a defective contact pin within seconds.

## Track and Insulation Test Editor

The track and insulation test finds solder short-circuits and interrupts and displays them.

Most faults are results of soldering defects; soldering short circuits make the greatest parts of them. With an automatic learning method in the track test editor, the complete tracks on the test item are learnt automatically in typically 10s and a test program is created out of them. You can place one or more contact pins per track so that you can also find interrupts on the PCB. In the track test you can also make manual changes so that e.g. low-ohm resistors which are displayed as tracks can be deleted and are only tested in the components test. If there are short-circuits, the tracks can be graphically displayed on screen.

## IC-Test-Editor

This test method was developed for the SMT-technology, in order to find solder defects which occur especially at LSIs with fine pitch-connections or at Ball Grid Arrays. This test range finds these faults without reservations to bus systems or technology. ICs can be displayed graphically on screen as Single-in-Line, Dual-in-Line, SO, QFP, PLCC, PGA or BGA etc. In case of fault, the graphical fault location can be shown in this way.

There is an optional software and optional selective amplifier PCB with 16 channels (max. 16 boards). Each PCB can hold 16 capacitive probes (=a total of 256 channels). The spring-suspended probe is applied to the IC from above with the test fixture.

The hard- and software described above is also required for identifying polarity of axial and radial electrolytic and Tantalum capacitors (see components test).

## Programming an IC-Open Test

The IC-Open-Test is generated semi-automatically. For programming e.g. a PLCC-IC you place the crosshairs in the graphical window on pin 1, click on it and the software at once recognises all the connected IC-pins. A learning mode learns all desired values and threshold values for the later test run. The pin-exact graphical fault location is generated in this procedure, i.e. programming an IC is finished in less than 20 s.

Measuring method: After all inputs of the IC have been applied to ground by the test system, all wired pins can be triggered one after the other with a signal of about 8 kHz below the threshold voltage. Capacitance is measured with the probe, which is applied from above, and the selective amplifier. You can also test connectors with this method. Time and again, connector systems are delivered with one or more parts of female or male multi-point connectors missing. This cannot be noticed from outside, but only when you connect them. With this method, complicated connector systems are measured fully automatically with 20 ms per contact. The necessary test steps can be generated automatically.

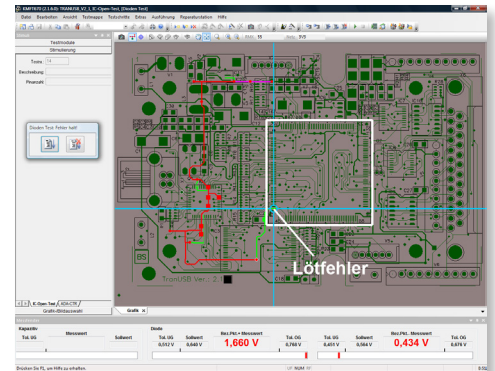

## Programming a Components Test

This editor is for testing components such as resistors, capacitors, inductances, diodes, zener diodes, transistors, FETs, thyristors, relays, opto-couplers, linear ICs, transformers etc.

There are three ways of programming:

1. manual with absolutely free wiring and without Gerber data,
2. semi-automatic programming with free wiring and use of Gerber data,
3. automatic programming out of CAD-data with autolearn of the complete measured values, with autoguarding and autodelay.

For the first method without Gerber data a printed circuit assembly and the circuit diagram are sufficient. With this method, you can plan typically 1 minute per component. You need the printed circuit assembly, the circuit diagram and the Gerber data for the second method. For the third method you need the printed circuit assembly, the circuit diagram, the Gerber data and the CAD-data.

### Programming a Components Test Manually

Why program manually when almost every CAD-system today can supply data and graphs for automatic program generation?

Orders are placed with companies who supply assembled PCBs (commissioned work) without any data but a sample, components list, printed circuit assembly and possibly position and printed circuit diagram, but even these PCBs must be in-circuit tested.

To begin with, a graphic file can be integrated for a later display of fault location. It can be created by scanning or by a picture taken with a digital camera. After the editor is called, 5 default windows open. In the left window, you select the graphic files you need for fault

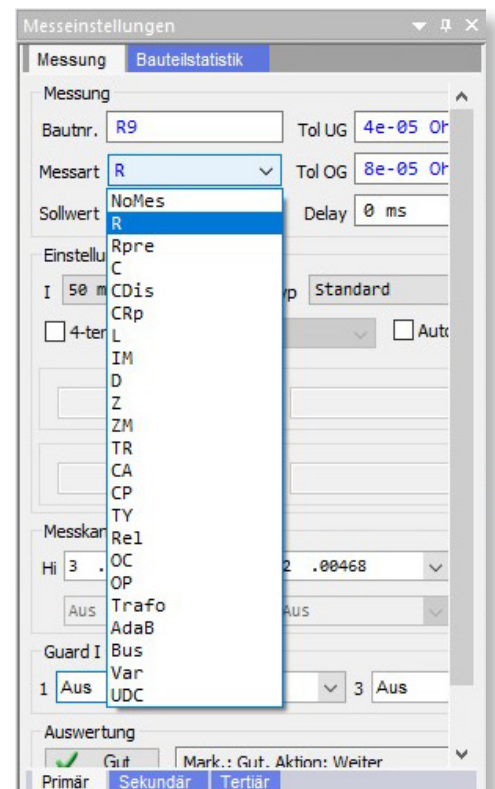

display. In the central one you have graphical display and in the right one you enter the data you need for a component measurement. After the component number, e. g. R130, the measuring mode (resistance measurement, capacitor or coil measurement etc.) you enter the desired value. The programmer does not need to take care of the settings of the stimulus signal and its values (voltage, current, frequency ...) nor the timing or the measuring ranges. The upper and lower tolerance limit is calculated automatically according to the set default values, but can be changed proportionally or numerically at any time. The delay between stimulus and measurement of the resp. component is shown in the "Delay"-field. This delay-time is usually found automatically by the system, but it can as well be entered manually. Then you enter the measuring channel high and low. With the search probe of method 1 you can also find it by contacting the track specifically. Press the measuring button so that the test system executes the measurement. In the lower part of the screen, the measured value is displayed in green in case it is "good". If not within the set upper- and lower limit tolerance,

the measured values and the analog measuring bar are displayed in red. If the measured value is red you can mostly find the resp. guard channel (even more than one) by activating the autoguarding and nulling parasitical components so that the correct measured value is applied. In the next step, the component to be tested can be marked with a crosshairs, so that in the test run the component is displayed as defective. For a further survey, a line with all important details for the resp. component is created for every component test step so that there is a listing on screen which you can scroll.

You just press a take-over key in order to create the next components test step. This copies the former test step and increments the component number by 1. Typical programming time for such a test step is less than 1 minute.

In the components test editor, you also program the test of polarised capacitors. For measuring polarised capacitors, a sine signal (ca. 5 to 6 kHz at 200 mV) is alternatingly applied. A capacitive probe measures the coupling (signal strength) on the capacitor housing. A

The screenshot shows the KMF1670 software interface for component testing. The main window displays a PCB layout with a yellow measurement path and a red crosshair on component R13. The 'Messung' (Measurement) panel on the right shows settings for component R21, with a measured value of 152,83 kOhm. The bottom status bar shows the measured value in green, indicating a 'good' result.

Nr	Testname	Bauteil	Messart	Sollwert	Tol UG	Tol OG	Delay	Einstellungen	RMX Hi	RMX Lo	Guard
357	R13	R21	R	155 kOhm	140 kOhm	170 kOhm	50 ms	1 µA, Standard, Autorange	53	54	Aus, Aus, Aus, Aus, Aus, Aus, Aus, Aus
360		D1	D	750 mV	700 mV	787,5 mV	0 ms	10 mA, Autorange	23	43	Aus, Aus, Aus, Aus, Aus, Aus, Aus, Aus
370		D2	D	280 mV	266 mV	294 mV	0 ms	10 mA, Autorange	2	49	Aus, Aus, Aus, Aus, Aus, Aus, Aus, Aus
380		BR5	R	2 Ohm	0 Ohm	4 Ohm	0 ms	100 mA, Standard, Autorange	23	29	Aus, Aus, Aus, Aus, Aus, Aus, Aus, Aus
390		LED2	Z	2 V	1,9 V	2,1 V	0 ms	10 mA, 3 V, Autorange	105	2	Aus, Aus, Aus, Aus, Aus, Aus, Aus, Aus
400		LED1	Z	1,86 V	1,767 V	1,953 V	0 ms	10 mA, 3 V, Autorange	2	81	Aus, Aus, Aus, Aus, Aus, Aus, Aus, Aus
410		R11	R	100 kOhm	95 kOhm	105 kOhm	0 ms	1 µA, Standard, Autorange	101	29	Aus, Aus, Aus, Aus, Aus, Aus, Aus, Aus
420		R11	R	100 kOhm	95 kOhm	105 kOhm	0 ms	1 µA, Standard, Autorange	126	29	Aus, Aus, Aus, Aus, Aus, Aus, Aus, Aus
430		R11	R	100 kOhm	95 kOhm	105 kOhm	0 ms	1 µA, Standard, Autorange	93	29	Aus, Aus, Aus, Aus, Aus, Aus, Aus, Aus
440		R11	R	100 kOhm	95 kOhm	105 kOhm	0 ms	1 µA, Standard, Autorange	88	29	Aus, Aus, Aus, Aus, Aus, Aus, Aus, Aus
450		R10	R	100 kOhm	95 kOhm	105 kOhm	0 ms	1 µA, Standard, Autorange	121	29	Aus, Aus, Aus, Aus, Aus, Aus, Aus, Aus
460		R10	R	100 kOhm	95 kOhm	105 kOhm	0 ms	1 µA, Standard, Autorange	94	29	Aus, Aus, Aus, Aus, Aus, Aus, Aus, Aus
470		R10	R	100 kOhm	95 kOhm	105 kOhm	0 ms	1 µA, Standard, Autorange	40	29	Aus, Aus, Aus, Aus, Aus, Aus, Aus, Aus

**Messung**

BauNr.: R21 Tol UG: 140 kOhm  
 Messart: R Tol OG: 170 kOhm  
 Sollwert: 155 kOhm Delay: 50 ms  
 Einstellungen: I: 1 µA Typ: Standard  
 4-term.  SMX  Aus  Autorange  
 Messkanal: Hi: 53 Lo: 54  
 Guard: Aus Aus Aus  
 Auswertung:  Gut Mark.: Gut, Aktion: Weiter  
 Fehler Mark.: Fehler, Aktion: Weiter

**Messfenster**

Test Nr: 110  
 1. Messung Sollwert: 155 kOhm  
 Tol. UG: 140 kOhm (9,7%) **Messwert: 152,83 kOhm**  
 Abweichung: -1.40% Bus Tol. OG: 170 kOhm (9,7%)  
 Guards: 26 Delay: 50 ms SMX/Probe: Aus

selective amplifier (polarity board) with very low input capacitance and high input impedance is connected before and amplifies the weak signal. Then the amplitude of the signal is evaluated by applying the signal alternately. There is an obvious difference between a minus and a plus signal (The signal is obviously higher at minus-application than at plus-application).

We also use this method for finding missing capacitors at blocking of ICs or for switching small capacitors in series with Elcaps.

## 2. Semi-automatic Programming

The Gerber data of the test item are the basis for this method. When the editor is called, five default-windows open. In the left window, you first choose the resp. Gerber files to start programming the components test. The Gerber assembly circuit in the central window also gives information on the wiring of the measuring channels. In order to find out, which test system channels are wired to the component to be tested, you aim the crosshairs to connection pin A of the component to be tested, Rx in our example. The connected conductor track flashes when you press the left mouse key. Pressing the right mouse key opens a context menu where you set if this pin is to be high or low. The same applies for the B-Pin (2nd connection pin of our resistor).

The test system knows now which measuring channels are connected. After you have entered the component number, e.g. R130, the measuring mode (resistance, capacitor or coil measurement etc.), you set the desired value. The upper and lower tolerance limit is calculated automatically with the set default values, but they can as well be changed proportionally or numerically. The delay time between stimulus and measurement of the component to be measured is shown in the delay-field. This delay-time is usually found automatically by the system, but it can as well be entered manually. Then you press the measuring button and the test system executes the measurement. In the lower part of the screen, the measured value is displayed in green in case it is "good". If it is not within the set upper- and lower limit tolerance, the measured values and the analog measuring bar is displayed in red. If the measured value is red you can mostly find the resp. guard channel (even more than one) by activating the autoguarding. For a further survey, a line with all important details for the resp. component is created for every component test step so that there is a listing on screen which you can scroll and can also be edited in the listing itself.

How does the test program work or branch out, if the measured value is not within its limits? If the measured value is OK, you will mostly go to the next test step. If the measured value is not within its permissible limits, there is an entry in the fault register and the system proceeds to the next test step. You can e.g. enter a "Halt" so that the test program stops after a fault and shows a message for the operator, e.g. "Turn switcher S1 on the test item to the right". The evaluation menu already offers all reactions which are needed for automatic test, e.g. NotAus, End, Loops, Goto; LoadGo ...

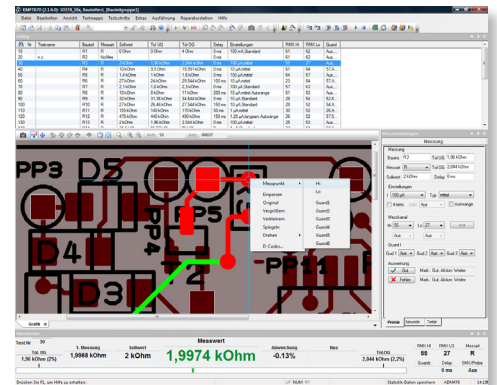



For creating the next components test step, you just press a take-over key. This copies the former test step and automatically increments the component number by 1. The typical programming time for such a test step is even shorter than that in manual programming, 30s per components test steps are absolutely realistic.

### 3. Using CAD-data

Our test system has got an interface for generating the program automatically via ASCII-data and autolearn. If your CAD-system has got an ASCII-interface, you only have to take care that the ASCII-data of your system and our system agree. A little post-processor will help. We have found that automatic program generation takes about ten minutes for about 300 components.

## Test Run

When the test system is booted after turn on, it automatically loads the test program which fits the fixture or it starts with the test program that was activated last. The operator only has to apply the test item in the test fixture and press the start key. In case of fault the test run is stopped. On screen there is a clear graphical error display and an analog measuring bar (components test) with the current measured value, the desired value and upper and lower limits. A choice-menu with numerous special functions is part of the test program: You can de-activate that the test system stops in case of fault. If there are no faults on the test item, this will be clearly shown on screen.

During the test run, there is a window which displays test functions, state and progress in the test program in percent. We also took care that the operator only gets the really important and necessary displays on screen and is not distracted or stressed by unnecessary graphical gadgets.

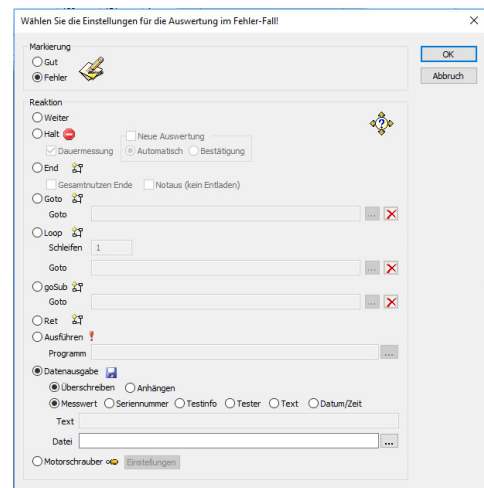

## Special Functions and Branch Out

How does the test program react or branch out if the measured value is not within the allowed limits?

If the measured value is not within its allowed limits, there is normally an entry into the error register and the program possibly proceeds to the next test step. Another mark could be a "HALT", i. e., in case of fault, the system always stops at this test step without an entry into the fault register. This is typically used in order to bring coding switches or bridges into a prescribed position for further test. This can of course be supported with a graphical display. NOTAUS is another possibility which is especially valuable for function test. If e. g. in a current consumption test, certain limits are exceeded, the system turns off all stimulus and measuring devices within a few milliseconds. Several other possibilities such as loop, execute external programs, write measured values into files or activate motorised trimmer can also be selected in this menu, i. e. all functions are necessary in practice.

## Multiple Printed Panels

There is a supporting tool for multiple printed panels which makes creating and tending programs easier for the programmer, because he creates only one program which is multiplied automatically. He only tends board 1 of the multiple printed panel. The other boards are changed automatically. In case of fault in the test run, the fault can be displayed to the very point on the multiple printed panel.

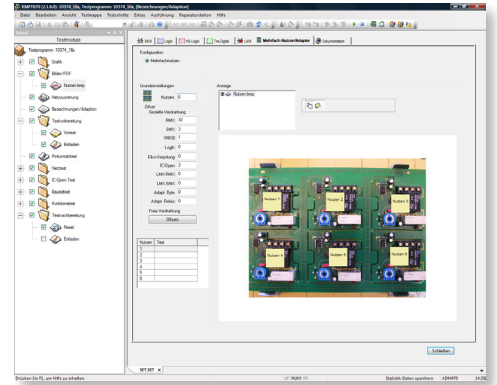



## Function Test Editor

The function test editor is made up of 5 parts:

The *survey listing* shows the test number, the test function, the PSUs, sources or loads resp., the measuring channel and the measuring range and the criteria for fail or good.

In the *stimulus field* (by default on the left-hand) you fill in the test number and information line and program the sources and PSUs, the stimulus matrix, IEC-devices or other functions such as resistance decade, ramps, motorised trimmer or other expansion modules.

Measurements are programmed in the programming field "*Measurement*" (by default on the extreme right-

The lower and upper tolerance limit can nevertheless be entered independent of one another directly or in percent. In the "*Delay*" field you enter the delay time between stimulus and the first measurement. This is necessary when a test item requires e.g. an allowed transient period until the measured value is constant. A comfortable autolearn method saves inputs. This autolearn method measures the existing values, uses the measured value as desired value and then uses the default values to calculate the lower and upper limit tolerances. Autolearn is started with the learn-button.

As there are additional possibilities for inputs for some measuring methods, there is a secondary measuring input window. In this field you can e.g. program "Unit". This enables you e.g. to execute a voltage measurement at a current resistor (shunt), which would in most cases bring results from 0, ... V, but if you enter "mA"

**Test step listing**

Testnr.	Messart	Sollwert	Tol.UG	Tol.UG	Delay	RMX.HI	RMX.LO	No1	No2	La1	Gen	Look	SMX	Siml. Auswert
3305	Schrauber an P2	NoMes			0ms	Aus	2	5V/1...	15V/1...	Aus	Aus	En		1,13,17
3306	U.Hf max. Abgleich	UDC	11V	11,5V	10,5V	0ms	108	2	5V/1...	15V/1...	Aus	Aus	En	1,13,17
3307	U.Hf max. Nachtest	UDC	11V	11,5V	10,5V	0ms	108	2	5V/1...	15V/1...	Aus	Aus	En	1,13,17
3308	U.Hf min. Abgleich	UDC	6,5V	6,9V	6,1V	0ms	108	2	5V/1...	15V/1...	Aus	Aus	En	1,13,17
3309	U.Hf min. Nachtest	UDC	6,5V	6,9V	6,1V	0ms	108	2	5V/1...	15V/1...	Aus	Aus	En	1,13,17
3310	Soll - Abgleich OP2	UDC	9V	9,1V	8,9V	0ms	108	2	5V/1...	15V/1...	Aus	Aus	En	1,13,17
3311	Schrauber abziehen	NoMes			0ms	108	2	5V/1...	15V/1...	Aus	Aus	En		1,13,17
3312	Nachtest	UDC	9V	9,2V	8,1V	0ms	108	2	5V/1...	15V/1...	Aus	Aus	En	1,13,17
3313	DAC C auf 64 prog	NoMes			0ms	108	2	5V/1...	15V/1...	Aus	Aus	En		1,13,17
3314	DAC C auf 15 prog	NoMes			0ms	108	2	5V/1...	15V/1...	Aus	Aus	En		1,13,17
3315	DAC C auf 16 prog	NoMes			0ms	108	2	5V/1...	15V/1...	Aus	Aus	En		1,13,17
3305	Ref messen 1.28V	UDC	1,28V											
3315	DAC C auf 16 prog	NoMes												

**Stimulus**

**Graphics, graphical programming and display of fault location**

**Measuring window**

**Measured value**

Test Nr	1. Messung	Sollwert	Messwert	Abweichung	Rampenwert	Tol.UG	RMX.HI	RMX.LO	Messart
3285	2,4 V (4%)	2,5039 V	2,5048 V	+0.19%		2,6 V (4%)	90	2	UDC
							Guards	Delay	SMX/Probe
							0	0 ms	1,13,17

hand). In the selection window "*MeasMode*" you select between more than 40 measuring modes. In our example we have selected UDC for DC-voltage measurement. In the "*Desired Value*" field you enter the desired value with its unit. After this value is verified, the system automatically supplies the TolUG and TolOG (lower and upper limit values). You do not have to accept the default-tolerances, but can e.g. enter 5V 2% (the desired value is 5V with 2% upper and lower tolerance limits).

in the unit-field and a measuring factor of e.g. 0.1, the correct value (e.g. 100mA) is displayed and recorded. You can also select reference, i.e. in any range of the system you can log the measured value as reference value and measure related to it or ratio in further test steps. You use the conversion factor for displaying the measured values in a different way by multiplication or division.

You enter special settings for the selected measuring mode in the "Settings" field. In our example you can directly select the measuring range for an UDC-measurement or an Autorange is selected.

Menu item "Measuring Channel" is used for finding out which measuring channels are used for this measurement. Each measuring channel can be used as both high and low by the test system. There are several ways of input. Either you select the channels directly or you use the Gerber files and just click on the resp. component pin in the graphics window (by default in the middle of your screen), press the right mouse key and set if it is to be entered as high or low channel. How does the test program react or branch out if the measured value is not within the allowed limits? In most cases you will proceed to the next test step if the measured value is OK. If the measured value is not within the allowed limits, there is an entry in the fault register and the program proceeds to the next test step. You could also enter e. g. a "Stop" which stops the test program in case of fault and possibly displays an order for the operator such as e. g. "Turn switcher S1 on the test item to right". All reactions which are necessary for automatic test, are already supplied by the evaluation menu e. g. NotAus, End, Loop, Goto, LoadGo...

In the field which displays the measured values, you will find all important measurement results. As the test system offers Online-Editing, you can execute every test step by pressing the F3-key or by activating the button for executing a test step. In this field the current measured value is displayed numerically and in a bar. If the current measured value is not steady, the bar moves back and forth. If the measured value is not within the set upper and lower limits, the digital measured value is displayed in red, as is the display in the bar. The first measured value is also displayed in this window. This is very important for programming a delay time. It reduces or possibly avoids a debugging for the test run.

The picture shows how the PSUs are programmed.

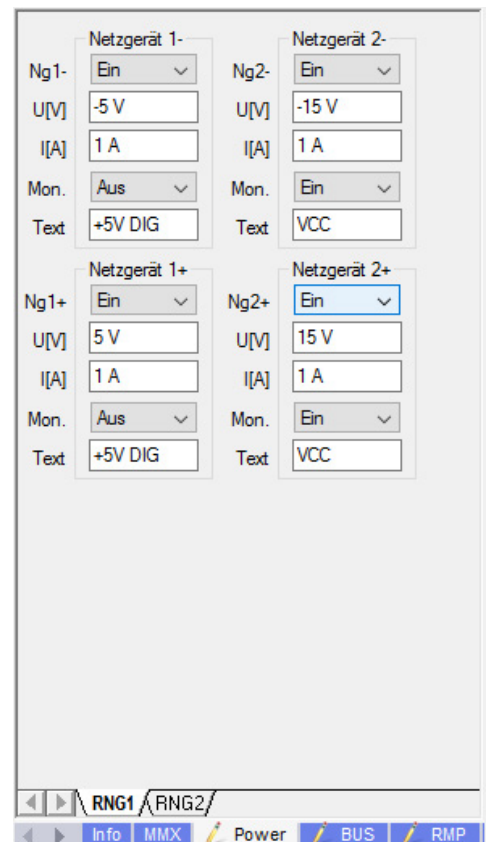
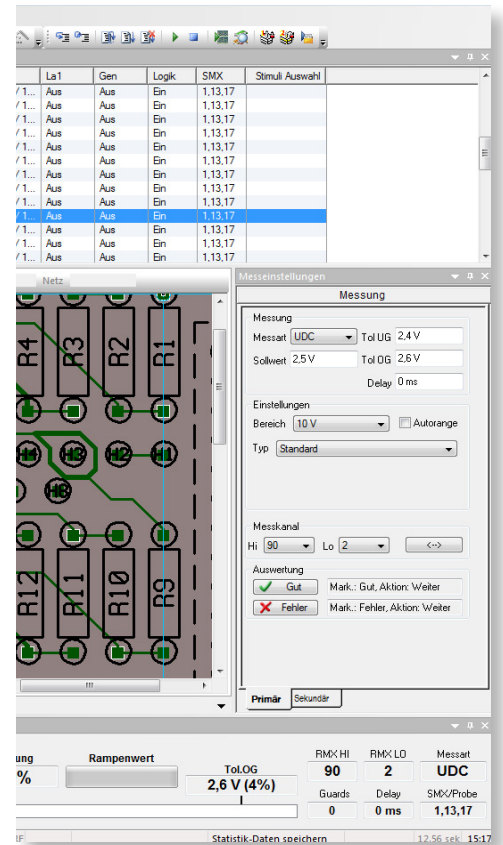

Next, the sine- and square wave generator are programmed with current limitation, offset and pulse duty factor.

In the *digital form* you program the bi-directional ALOG670 logic board. It is used for stimulating the test item with logic combinations and evaluate and measure them. First of all the logic channels are assigned to the test item and busses are created (e.g. data bus). The data connections should be named (e.g. Data6), so that there is always a clear recognition and documentation.

In the stimulus window, you can then program the driver level, the comparator level, high and low. You can do this on the keyboard. **Up** is for the driver on log.1, **Down** is for the driver on log.0, **High** is for a comparator with log.1, **Low** for a comparator with log.0. **\_is** for Tri-state, **Pos** for a positive pulse and **Neg** for a negative pulse.

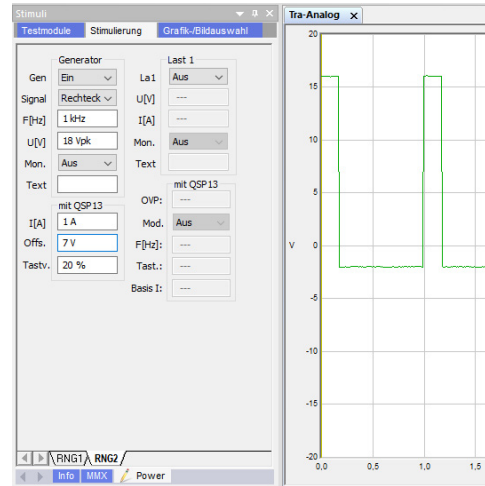

In the graphical logic programming window, the channels (max. 256) are shown from top to bottom, the number of test steps is shown from left to right. If several busses are used, each bus is displayed in a different colour. The graphics also take into account if busses or connections are drivers (bold lines) or if they are comparators (regular lines). Dotted lines are for Tri-state. You can stimulate or evaluate the bus systems with decimal or hexadecimal input. There are also comprehensive software generators, which can simulate stimuli in random patterns, binary sequences, chess board pattern and a number of other possibilities. Via autolearn, the program is generated automatically within seconds on a test item which is known to be good. Needless to say, you can enter bit by bit manually – nevertheless automatic programming reduces the programming time enormously. You can see at any time if all channels have shown reaction during programming so that test accuracy is high. Entering delay times, duplicating parts of the program in width and length is also a comfortable basic part of digital programming.

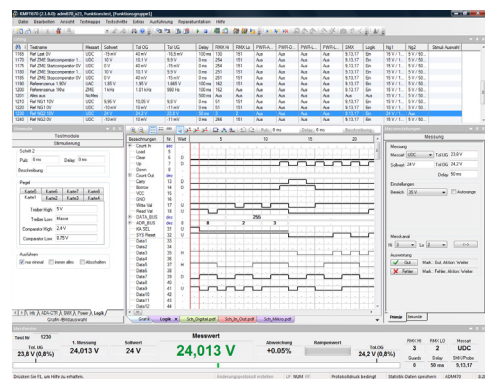

The (optional) transient recorder is used for recording AC- and pulse voltages with a maximum internal sample rate up to 100 ns. The auto-key is used for setting amplitude, offset and time base automatically. You can select this with the input voltage divider in 1, 2, 5 steps, you decide on AC or DC coupled. The time base is again set in 1, 2, 5 steps and you set the trigger levels and select the triggering. The parameters are entered on the right of the form "transient recorder". After a single key-stroke it starts measuring and displays the signal on screen. You can choose cut-outs of such curves which are enlarged, pulses and curves can also be measured in 8 ranges and be displayed numerically. You can enter limit values for those 8 parameters which are then measured individually. Nevertheless it is best to generate an envelope curve which can be selected with various limit values.

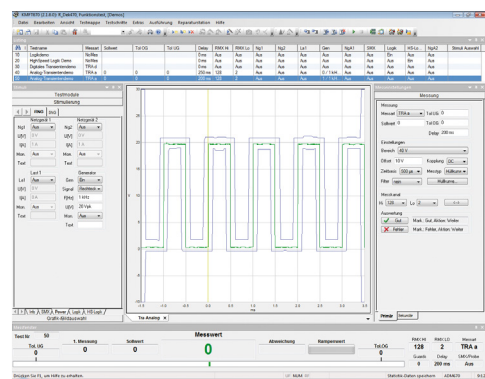

## Fieldbusses

With a BUS-system you can transmit data to the test item or to a measuring device. In the stimulus field, data can only be transmitted. Data can be received with the "BUS" measuring mode. At the moment, busses IEC, I2C, COM, Int37, CAN, VISA, I2C-EEP, Profibus, eBus, TCP/IP, Ser, SPI, ODBC are available. By default, the data are interpreted as ASCII-text. When transmitted as binary values, you may choose between decimal, hexadecimal and binary display.

BUS	Used Hardware	Series
IEC	IEEE-interface board in the PC	no
I2C	integrated I <sup>2</sup> C-Bus of the DEC670 multi-function board	yes
COM	PC interface	yes
Int37	REINHARDT-Interface for test system control	yes
CAN	CAN-inteface board in the PC	no
VISA	integration of the VISA-software interface	yes
I2C-EEP	integrated I <sup>2</sup> C-Bus of the DEC670 multi-function board	yes
Profibus	Profibus-interface board in the PC	no
eBUS	eBUS via eBUS-adapter by DUNGS	no
TCP/IP	communication with various devices via Ethernet-interface of the control computer	yes
Ser	integrated COM-interface on the DEC670 multi-function board	yes
SPI	integrated SPI-interface on the DEC670 multi-function board	yes
ODBC	software-interface for communication with a data base management system	no

As the DEC670 multi-function board is not used in the ATS-UKMFT-family, its busses are not available, too.

Apart from these bus systems there is the bus "Buffer" in the bus measurement for the evaluation of the internal software buffer. No new data are gained via a bus. With "Buffer" you can also evaluate a file.

## Integrating External Programs

External programs enable you to integrate external software in a test run. You can also read out the contents of files and evaluate them within the test program. This measuring mode helps to execute an external program and take it over again by the test system. If an external program is called, the program can be controlled by program parameters. When an external program is called, this program remains active and the test system-software remains open in the background. When the external program is closed, the test system-software comes into the foreground and continues to execute the program.

Bus

Art: COM

Konfig.: #1 9600 N 8 1 -

Adresse:

Init: \*CLS 13

Trigger:

Attribut Fehler Reset



### Fault Journal

There is a hard copy of the fault journal below as it is set (default) when a test system is delivered. The customer may use the EXCEL®-software (which is not part of our delivery) in order to create his own layout for editing the desired values. He can also supply his company sign etc.

Testmappe: TM\_adm470\_v21  
Seriennummer: ADM0014

Isolationsstest Fehler  
Netz 117 verbunden mit Netz 177  
Netz 177 verbunden mit Netz 117

IC-Test/IC-Gruppe1/Schritt 10: PLD1 Fehler  
fehlerhafte IC-Pin-Nummern: 5

Bauteiltest/Schritt	Passive Bauteile/Bezeichnung	Messart	Untergrenze	Messwert	Obergrenze	Ergebnis
1820		R	261,9 Ohm	179,97 Ohm	300 Ohm	Fehler
<b>Funktionsstest/Funktionsgruppe1</b>						
Schritt	Bezeichnung	Messart	Untergrenze	Messwert	Obergrenze	Ergebnis
1155	Ref Sinus Amplitude 0V	UDC	-16,5 mV	Overflow	40 mV	Fehler
1160	Ref Last 10V	UDC	9,9 V	0,0009 V	10,1 V	Fehler
1170	Ref ZME Startcomparator 10V	UDC	9,9 V	0,0125 V	10,1 V	Fehler
1180	Ref ZME Stopcomparator 10V	UDC	9,9 V	0,0064 V	10,1 V	Fehler
1200	Referenzsinus 1KHz	ZME	899 Hz	5,00 Hz	1,1 kHz	Fehler
1250	Spannungsquelle +10V	UDC	9,9 V	-3,9474 V	10,1 V	Fehler
1260	Spannungsquelle -5V	UDC	-5,05 V	-3,9890 V	-4,95 V	Fehler
1270	+10V am Messbus	UDC	9,9 V	-0,0332 V	10,1 V	Fehler
1280	500Hz für Transistor	ZME	494 Hz	0,00 Hz	506 Hz	Fehler
1290	+10V an Guard	UDC	9,9 V	-3,9630 V	10,1 V	Fehler

### Quality Management – Reference Test

Prüfung fehlerhaft

2 fehlerhafte Netze im Isolationsstest  
1 fehlerhaftes IC im IC-Test  
1 fehlerhafter Schritt im Bauteiltest  
10 fehlerhafte Schritte im Funktionsstest

Testname: TESTSYSTEMADMIN  
Datum/Zeit: Donnerstag, 29. Oktober 2015 11:49:20

Unterschrift:

More often, reference tests are specified in testing requirements. Based on a test item which is known to be good, the function of the test system and the fixture must be checked and documented after a specified number of test runs or after a specified time interval. As soon as the number of test runs or the time interval is reached, the test system is blocked and testing can only continue after the reference test. You need an ADAEEP fixture recognition module for the reference test.

This reference test complements the [System Diagnose](#).

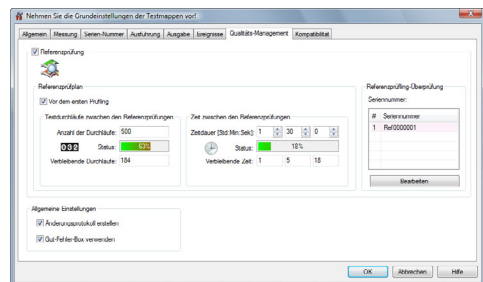

### Program Generators for Function Test

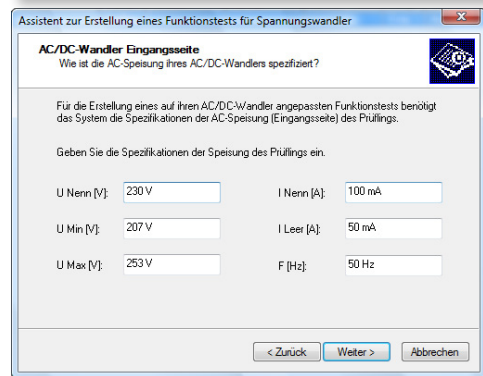

In developing this software our 25 years of experience in power supply test was taken into account, because we wanted to share our knowledge and experience with our customers. Therefore, our complete knowledge was made part of this automatic program generator and we have developed a standard valuable tool for programming and wiring in function test. This wizard enables even an inexperienced operator to create an executable, efficient and expressive function test program for power supplies and transducers in a few minutes. The wizard first demands the kind of primary supply, AC or DC. Then it lists e. g. all available AC-sources in a pull-down menu. A new form appears in the next step where you only enter the nominal voltage (e. g. 230 V) and the minimum and maximum supply level. The maximum primary power supply (Imax) can be entered as well as the minimum no-load current. With an AC-supply, the frequency is also entered. In further input forms you describe the outputs. When the nominal voltage is entered, the system proposes +/- 10 % by default which can of course be changed again. Apart from that you enter the maximum current, the current limit values and the frequency for an AC-supply.

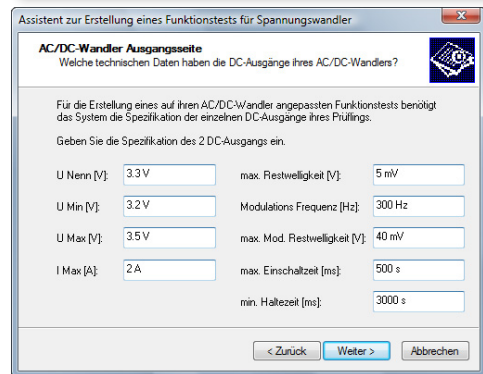

The wizard then asks you for the number of primary outputs and asks you to enter the technical specifications into the respective fields.

In these fields you enter Umin, Umax and Imax as well as the max. residual ripple, the modulation frequency, max. activation time and minimum stop time.

When all values and limits are entered, the system again proposes the available electronic loads. The wizard takes care that the respective modules fit the required specifications.

The entry for the DC-supplied power supplies is similar. The software then creates the test program for the test item with nominal voltage, minimum supply and maximum supply. Efficiency, residual ripple etc. are tested. In parallel the software creates a wiring plan which only has to be realised identically. So a very good test program is already available which can be expanded with additional test steps at any time.

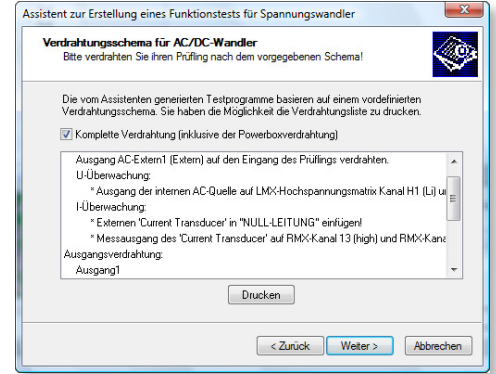

### Modification Listing

The modification listing grants a complete documentation and history of any change in a test program for the electronic PCB. There is information as to when incl. date and time, where (test device), maybe who logged in and detailed information on the changes.

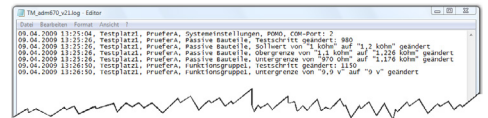

### Statistical Calculations on Faults and Parameters

Our test systems come with a comprehensive statistics package as standard and this will for example print the measured values of all the handled units to test and then process them as required. We supply two modules for further processing. The report on faults is expressed as a percentage and also the number of defective units is displayed. Then there is a graphic representation complete with fault frequency distribution which can be used to produce a histogram or calculation of the relevant statistical values. The values displayed include: highest measured value, expected value scatter, scatter, 3 sigma limits, above/below, and a graphic representation of the distribution curve. These parameters provide quality control with useful evidence for improving the product and recognising early failures which are represented by asymmetrical distribution curves and taking steps to eliminate them. The statistics can be produced completely automatically or they can be calculated on a separate computer.

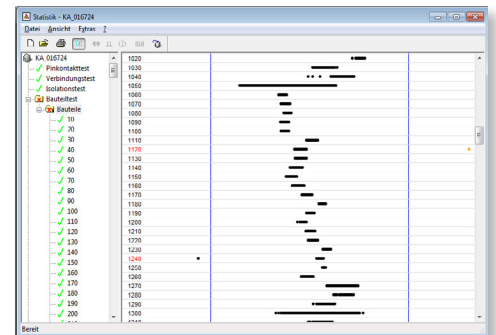
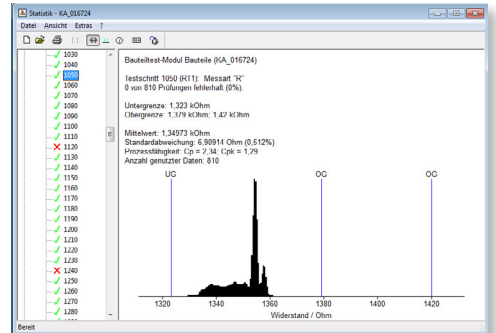

### Open Database Connectivity – ODBC-Interface (Option)

Sometimes the REINHARDT-test system is integrated in quality management or production procedures with data base management. By default, statistics data can be interpreted separately and supplied for processing in a data base with the Export function of the statistics software. An interface of the REINHARDT-test system to the data base grants further facilities. The data transfer can be configured so that the data base management system can process the information for quality management, statistics, etc.

The required data base is selected with the ODBC-interface and a connection text is generated. In the test run, this text is used for selecting the data base where the data are stored. Then the table

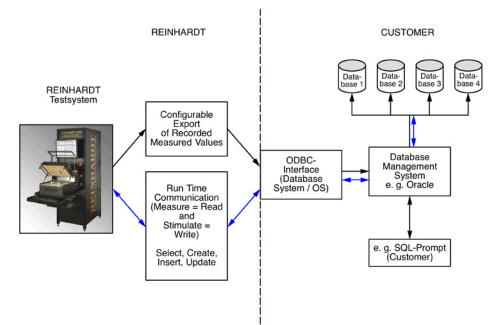



is chosen which stores the data. For that you may use an existing table or generate a new one. When the table is selected, its fields are listed so that only the data sources must be assigned. If the name of a table which does not exist yet is entered, the required fields must be selected and connected to the data sources.

### Downloading FPGAs or Software

Within the last years, we had to learn in many applications that it is necessary to fuse FPGAs or similar elements and to load special software in the test procedure. Depending on the application, these tasks can be executed by our serial interfaces RS232 or I<sup>2</sup>C, but also with our HighSpeed-Logic and the static logic channels to a single depth of 8K. With RAM-information above 8K, they can be repeated. With RAM-information in the MegaByte-range, we would recommend to integrate programming systems common in the market. Our software is prepared for that.

### ODT Optical Display Test (Option)

LCD and LED-displays, dot matrix, mask and seven segment displays are widespread and must be tested. A USB-video camera with any resolution supervises the display. The displayed numbers or letters are read, independent of font or typeface. The results are processed in the test procedure. A dot matrix can be evaluated. An automatic black-white adjustment is possible as is automatic adjustment. Contrast or intensity of the display are checked. For seven-segment displays and dot matrix, there is a comfortable editor with auto-learn functions and a character library. In board assembly, displays are often soldered or mounted a bit crookedly. Therefore, an automatic xy-adjustment or alignment with programmable limits has been integrated.

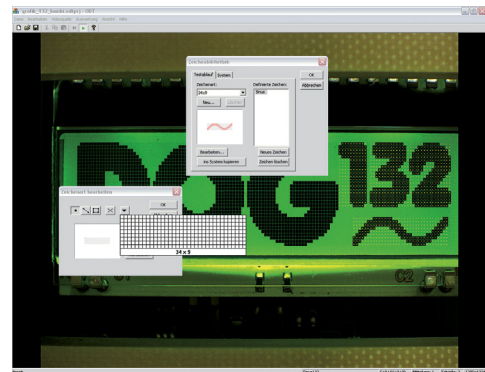

### Display of Fault Location

You must choose the right test method in order to get the best test and an optimum fault isolation. After the test system has found a fault, you can indicate this fault visually on the screen by only one key stroke. For that, a video camera takes a picture of the test item. This picture is digitised. The fault is graphically displayed with a crosshairs or a frame around several objects. Another software works out CAD-data. These pictures can be taken from any CAD-system working with graphics boards and transferred to the test system. Again, you need a special board in your PC, a video camera, black-white with tripod and a control software. The information gained in this way can also be used on the off-line repair station, so that a repair is possible without any technical papers.

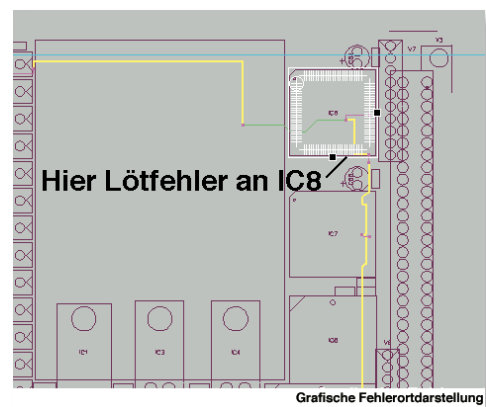

## Boundary Scan

Sometimes there are constellations on BGA- or  $\mu$ BGA-components, where connections for the In-circuit test are not accessible mechanically. A Boundary Scan test can be suitable in this case but it has to be prepared in development and design of the electronic PCB. Boundary Scan only requires two additional bus connections, the TCK (Test Clock) and the TMS (Test Mode Select) which are connected in parallel to any IC used in Boundary Scan. Digital Boundary Scan can check connections between the resp. circuits. A short-circuit can also be found. A digital signal pattern is applied to the IC-pin under test (Test Data Output TDO). The connected IC (ICs) is scanned via Boundary Scan, if the resp. signal pattern is applied (Test Data Input TDI). Since more and more electronic components such as CPLD or FPGA and more and more bus components too are Boundary Scan-capable, this can prove a comfortable expansion for a combined In-circuit and Function test.

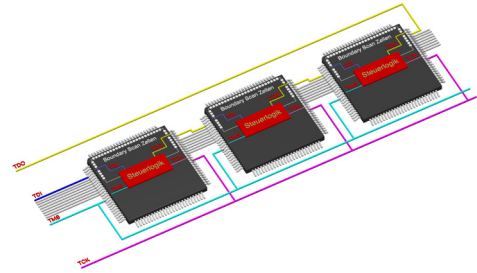

REINHARDT-test systems with their combined In-circuit and Function test offer a perfect surrounding for expansion with Boundary Scan-test. In case certain points of the DUT cannot be addressed directly via Boundary Scan, you can do that via the very cost-effective bi-directional logic channels of REINHARDT-test systems (e.g. LOG 96 Logic Board).

The RBS 100 (REINHARDT Boundary Scan) module is completely integrated in the user-friendly software of REINHARDT-test systems. As in other REINHARDT-solutions, only the Gerber files and the BSDL-data (Boundary Scan Description Language) of the ICs are required for creating a Boundary Scan-test program.

Nr	Testname	Messart	Schwert	Tol UG	Tol OG	Delay	RISX H	RISX Lo	Ng1	Ng2	La1
1000	Flussleiter?	UDC	5 V	50-mV	1ms	420	2	5 V/1	Aus	Aus	Aus
1070	Falsch LED EPLD	FANB.	180	170	180	0ms	Aus	Aus	5 V/1	Aus	Aus
1080	Falsch LED MICRO	FANB.	180	170	180	0ms	Aus	Aus	5 V/1	Aus	Aus
1090	Falsch LED ACCESS	FANB.	180	170	180	0ms	Aus	Aus	5 V/1	Aus	Aus
1100	Clock 120Hz messen	ZME	12 MHz	11,989 MHz	12,011 MHz	1ms	285	2	5 V/1	Aus	Aus
1110	Master Clock 30Hz messen	ZME	30,780 kHz	30,820 kHz	30,920 kHz	1ms	422	2	5 V/1	Aus	Aus
1120	Fluss Puls messen	ZME	300 ms	270 ms	330 ms	0ms	230	478	5 V/1	Aus	Aus

**DAC-Messung**  
Messwert: 5,0032 V  
Abweichung: +0,06%  
Tol.UG: 5,016 V (0,3%)

**RAM-Test**  
Messwert: 4,985 V (0,3%)

**Bustreiberprogrammierung**

**SPI-Programmierung**

These data are used for graphical display of fault locations and the connections of the single ICs.

### RST 40 REINHARDT-Synchro-Test

When the test station in the electronics test bay proves to be the bottleneck in production because of ever more comprehensive tests or because more and more test tasks are executed on the test station with its bed-of-nails apart from the in-circuit- and function test, the ever growing test speed cannot compensate this. With the RST 40 REINHARDT-Synchrotest module, a threefold or fourfold test is executed in parallel just like a mixed test with the in-circuit test on one station and the function test on a second station etc. With the so-called multiple project, e. g. with 3 different PCBs, different types of electronics PCBs can be tested simultaneously. Even somebody who is not very familiar with network programming, with C++ or Visual Basic can integrate the REINHARDT-test systems in a network with this module. four systems can save 400 % test time.

This software module allows remote programming, diagnose and control via network so that one or more test systems can be controlled, monitored or tested from wherever you want.

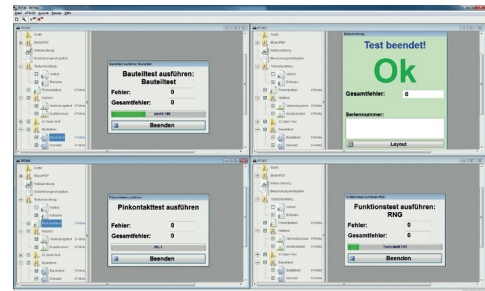

### Programming Station

If your test system has no capacity left for programming tasks, you need a programming station. Programming can be offline on any PC-computer. You only need a copyright. This programming station can be connected to the test system via networking, but programs may also be stored to disks which are in turn stored to the test system. You may use one or more programming stations, but you need to buy a software-copyright for each of them.

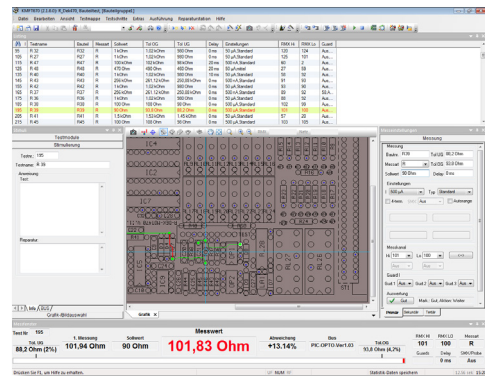

### RDR Repair Station

We have developed the REINHARDT Offline Repair Station for our WINDOWS®-based test systems. The repair station software can be installed on an offline repair place or on the test station and with a further licence on two stations at a time. The software comes with an USB-dongle so that it can also be used alternately on various stations. With the RDR-software PCBs can be repaired offline with complete graphic display of faults. It also displays the respective test step with all its information such as e.g. measuring range, upper/lower limit, comments, measuring channels etc. With the repair station, the test system need not be used for repair so that there is higher throughput of devices under test. This software uses the statistical data of the PCBs. Working with an offline repair station is only possible if the devices under test are clearly identified by a number or a text, such as e.g. a serial number. In the statistics data the number of repair

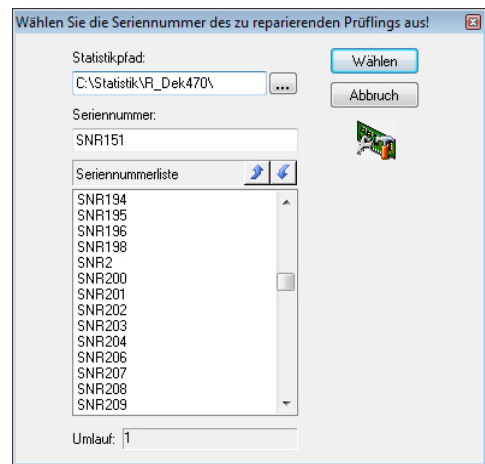



runs is recorded and added so that the person who repairs soon notices how often this PCB has already been repaired. After every successful repair, the identification mark is deleted from the list of serial numbers so that it is no longer mentioned to the person who repairs. A PCB is successfully repaired if it goes through a successful test run on the test system. For the RDR-software we recommend a PC with a processor in current multiple core technology and at least 2 GB, but 4 GB RAM is better. The software is networkable so that there is access to data on a central server.

### REINHARDT ASCII-Interface

As all REINHARDT-In-circuit test systems, the test system-software has an ASCII-interface for the In-circuit test for a cost-effective transfer of CAD-data. All important data of the components can be accepted for creating a test program. A test program is then generated automatically - with guard channels, delay time etc. You just have to generate a post processor which accepts the CAD-output data for the Reinhardt-ASCII-interface. Each line in this ASCII-file, corresponds to a component test: first position component number R3, next position possibly a name (resistor), then the type of measurement, i. e. an R-measurement with a resistor, in the following positions desired value, upper limit, lower limit, measuring channels... Some lines are shown below as an example:

```
R3→Widerstand3→R→10e6→11e6→9e6→RMX:5→RMX:2↵
C4→Kondensator4→C→100e-12→110e-12→90e-12→RMX:9→RMX:2↵
V2→DiodeN4148→D→ → → →RMX:15→RMX:13↵
```

```
V6→Trans.2N2219→NPN→ → → → →RMX:20→RMX:32→RMX:33→1.5↵
```

### RUDC Universal Data Converter for Data Transfer incl. Eagle Interface (Option)

is a cost-effective alternative and universal solution to extract data from diverse CAD-systems and process them for the REINHARDT-test system software.

Eagle with its manifold functions provides a way to generate Gerber data for graphical display of fault location almost fully automatically. The Gerber data together with the bill of materials are used as the basis for the converter software and make up the framework for the component test.

Another feature of RUDC10 is the import of the data which are also used for the pick-and-place machine. These are component reference (R14, C22), package type (SOT23), value, centre point coordinates and orientation. The data which were generated with the REINHARDT software package for processing Gerber Data are used in addition. These data are available for service providers as well as for own developments. After the bill of materials and the data for graphical display of fault location (computed Gerber data) are imported, the automated autolearn tools such as e. g. for pin contact test, shorts

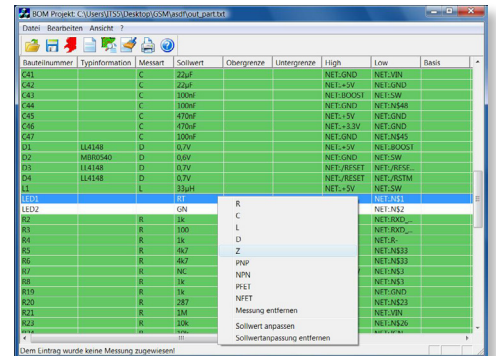

and isolation test and the APG in the component editor as well as the component statistics can be used. Conversion of the data is widely automatic and is easy to understand even for inexperienced users.

### Transfer of Bills of Materials for Creating Test Programs for the REINHARDT-In-circuit Test

Our extremely practice- and user-friendly transfer of bills of materials (also known as BOM) for creating complete in-circuit test programs does not require any special knowledge in information technology. You must only know how to use a PC. Our solution is a very cost-effective alternative.

Every CAD-system for the development of electronic PCBs which is up-to-date, can edit bills of materials. This is absolutely necessary for outsourcing, both in producing PCBs as in purchasing components. With an EXCEL-software we read in the bills of materials, sort them, delete unnecessary information such as e. g. company heading etc. With cut and paste, the sequences of the columns are then sorted as required by the REINHARDT-CAD-Import. By generating a Macro, these steps of the procedure with the EXCEL-software can be simplified and automated. The created file is exported as ASCII-file and can now be imported in the standard import of test system. The test system software reads the processed EXCEL-list and automatically creates a program. The Gerber files of the PCB-creation are used for creating a layout with the connection points. The connection points of every component are learnt in a few seconds by clicking on the connection pins. Our automatic program generator generates 300 components in typically 3–4 minutes. The set desired values with their tolerances are learnt from a PCB which is known to be good. Guarding follows and up to 8 Guard points are transferred to the program. Debugging, i. e. delay times which arise by loading capacitances, is generated automatically and transferred to the program. The few test steps that could not be generated in this procedure are marked red and must be checked. Mostly there are blocking capacitors of the various ICs. As they are connected in parallel, a new test line must be created which lists all these capacitors. This also applies to resistors which are connected in parallel. In this way, a comprehensive in-circuit test program can be created in typically 3 hours, but without an extremely complex software.

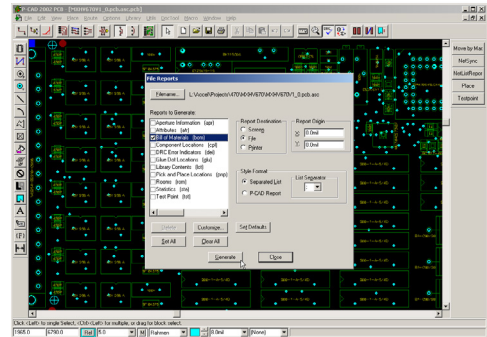

*Creating a Bill of Materials*

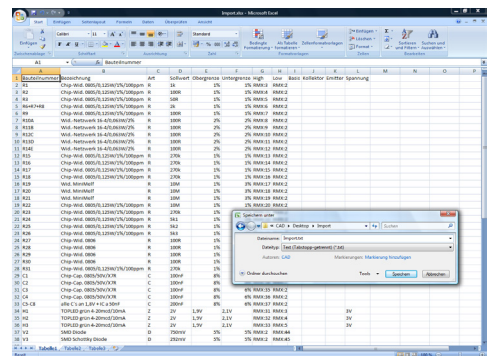

*Save read-in and processed file*

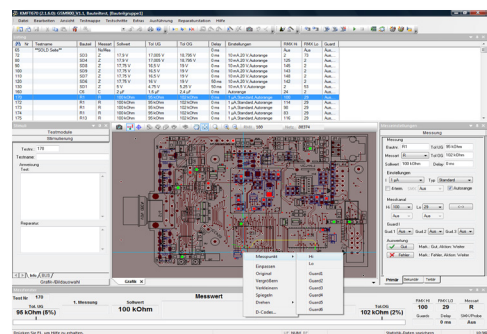

*The automatically created program*

### OLR-Software – Optical Layout-Reconstruction for Creating a Test Program and a Fixture

If no Gerber files are available, you can generate the necessary data for creating a test fixture. The solder side of the PCB is scanned, with SMT the component side too or both sides are scanned. The PCB can be aligned and rotated and you can enter its outside measurements. The completely assembled PCB is then rectified 1 : 1 on screen. There are software tools for generating the test points of the ICs. Thus you can generate all test points for e. g. an IC with 128 pins in a few sec-

onds. A grid which can be set and moved is for exactly positioning the contact points. The remaining points, single points, multi-way connectors as well as PLCC-cases can be generated and positioned 1 : 1 on the test item. You can also process the generated files to a drilling machine which then drills a test fixture. Scanning the PCB and inserting the IC-overlays or test point-overlays resp. usually takes 10 to 15 minutes.

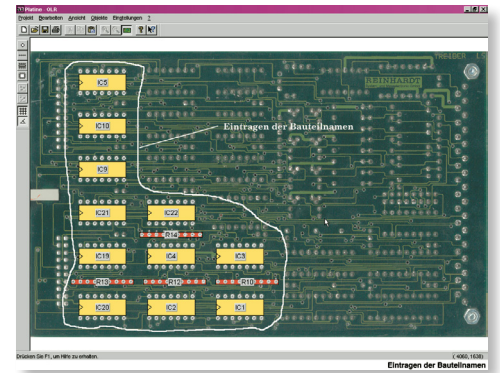



## Our Complete Solution incl. Fixturing

A test system, whether for In-circuit or for Function test, can only be used in a reasonable way, if the item under test, PCB, hybrid, module or SMT-PCB, can be connected as well as possible for a most comprehensive test. We have always tried to produce cost-effective test systems with an extremely user-friendly software. Our solutions for fixturing are extraordinary: We have developed various systems for fixturing which are unusual in costs, user-friendliness and space needed for them. Testing has become economical even with small units. Our semi-automatic system for building fixtures can be used together with our fixtures. In less than one day you can thus create a solution for many hundred pins at your own site.

### Various solutions for building test fixtures semi-automatically by using Gerber files

In Germany and Western Europe it has become pretty expensive to produce and test PCBs because of the wages and the costs around them. Many companies have therefore shifted their large scale production to the Far East in order to produce more economically there. This brings about that there are only middle and small-lot productions on the German and the European markets. This is why things had to be thought over in testing and especially in building fixtures. Years ago, production runs with 100,000 and more pieces per type were absolutely common. In the meantime, the numbers of pieces have diminished pretty much. Nowadays, one can hardly plan in this way. In the past the costs for fixturing could easily be allotted to the number of pieces – testing nevertheless remained economical. In the meantime, the structure of the market has changed in that a big part of the electronics is produced by mechanical engineering industries as well as by their sub-contractors. There is an enormous variety of types in this field therefore, with limited numbers of pieces at that. Today, there are production lots between 200 and 400 pieces. In creating fixtures for such lots, especially in the in-circuit test field, the costs very often run up to sums in between 4,000 and 10,000 Euro for both preparation and creation. You also have to pay the capacity/non-capacity of the service industries. These costs can in no way be apportioned to the numbers of pieces given above. Therefore it has become necessary to think about new ways for such lots.

We have made fundamental changes in the preparations for a fixture as well as in the final mounting of the fixture with the corresponding systems. We deliver the *semi-automatic system* (software and CNC drilling machine), which calculates the positions of the test pins, drills the fixture and places the pins. *It helps you to create a fixture on your own – in your own house in less than one day. Please ask for a detailed quotation.*

The following diagram shows the structure of the tasks:

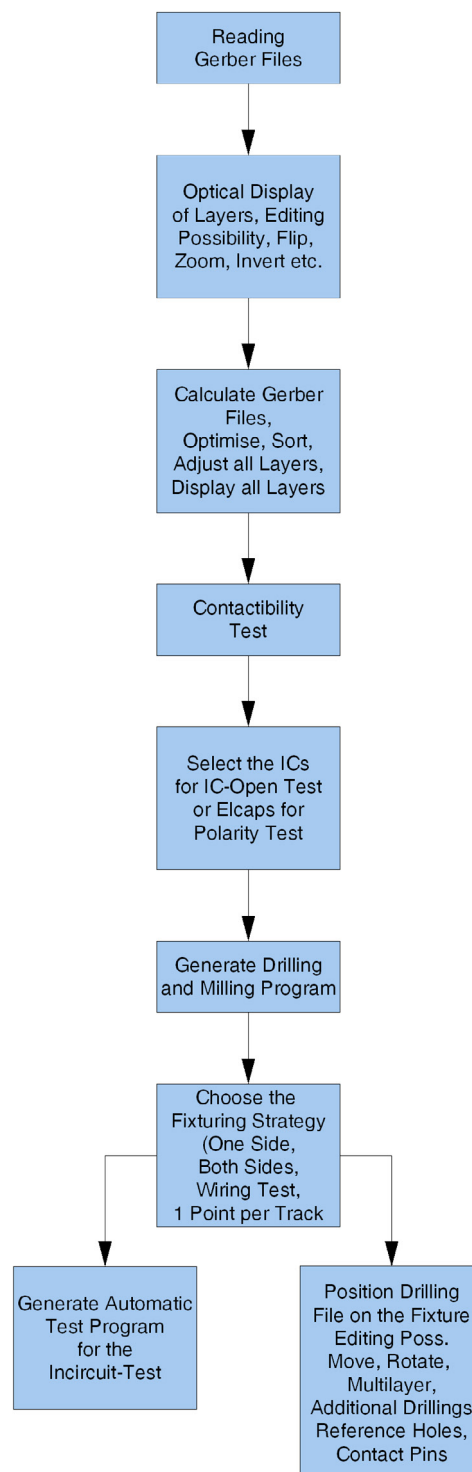

## Elaborating Gerber Files

Without exceptions, all CAD systems offer Gerber data, the only common standard of CAD systems. That is why we use these data which are made up of single vectors. With them we calculate complete conductor tracks with the component drillings and the through-connections. The single layers (up to 255) can be graphically displayed on screen, either one after the other or all at the same time, or they can be edited if needed. Various D-Codes can be extracted of the displayed layers and single layers can be reflected. When all the layers are congruent, the software starts recalculating all tracks. This process is worked out within a few minutes, even for double-Eurocards in multi-layer technique. In a menu, you finally select if either all terminating points of the tracks or only one drilling per track is used for creating a fixture; of course this is displayed graphically. This software also checks the minimum distances between the monitoring points: It displays a message if you can no longer use 100 mil-contact pins (cost-effective, robust), because they are too close or that you have to use a 75 mil-contact pin (blue frame) for this monitoring point. Two monitoring points marked in a red frame mean you can only use 50 mil or even smaller contact pins here (if possible you should avoid this, as they are expensive and not robust.). The user should try to avoid such narrowings and use a suitable other test pad, even if this causes a re-design of the PCB. Tracks which are not contacted are flashing, i. e. they are not contacted, e. g. if IC-pins were connected with a track below the IC or if fixturing is from one side only and the track is on the side of the PCB which cannot be contacted from this side. As soon as everything is corrected or accepted, you place the reference pins or items which support you in inserting the boards. Finally the drilling diagram is positioned on the usable area of the fixture. This is done by centering it or by rotating. The usable area of the fixture can be used by some drilling programs so that two or more devices under test can be set on one fixture box if the test items are small.

The whole process for editing, displaying the PCB, creating the tracks and the drilling data takes about 10 minutes. These processes take about 2 to 3 weeks less than they used to when done in the manual technique used until now.

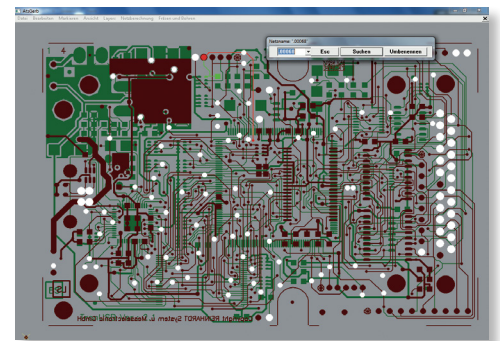

## Building Fixtures

The CNC drilling machine we offer is a package which contains hard- and software, box for 630 receptacles with spring contacts and sub-cabinet, but neither computer nor monitor. This three-dimensional CNC-drilling machine has got a slide travel of 395 mm (X axis), of 300 mm (Y axis) and 140 mm (Z axis). Accuracy is 20–30 $\mu$ , repeat accuracy is 10 $\mu$ . The unit requires compressed air, not lubricated, 6 bar pressure at a quantity of 50 l/minute.

Supply: 230 V

Dimensions: 80 cm high, 80 cm wide, 100 cm deep, weight about 110 kg.

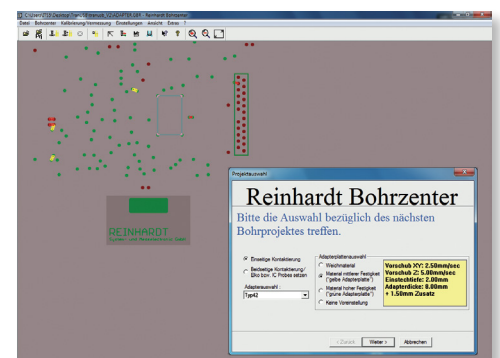

Using the data which have been gained and selected out of Gerber files, the laminated paper plate is drilled for the contact pins, the reference pins, guidings and perhaps the IC-Open probes and polarity probes. You neither have to take care of offsets or other special inputs when you want to use the fixture drilling center as the dimensions of the plates are known and there are fixed holders for them. All holes can be drilled into the laminated paper plate true to gauge in less than one hour. A special press-in device, which is also controlled by the CNC-machine, supports this procedure. The spring contacts with receptacles are pressed in automatically with high accuracy. Using the D-codes, the system selects contact pins with different heads from the bi-partite magazine. You have to use different heads if you have chosen different contacting points. The contact pin of a wired component e. g. would be contacted with a crown, an open feed-through or a test pad would be contacted with a tip. On the whole, this process takes less than two hours. Wiring with wire-wrap cables follows. We have prepared cables with connectors on both ends. With them, the connector which contacts the test system is wired to the spring contacts. Wiring about 300 connections approximately takes you two hours. A test fixture incl. the calculation times of the Gerber files can be finished completely in about 4 to 6 hours.

### Test Fixtures

We grant that, from the very first thought until it is finished, a fixture can be made in less than one day. You therefore need a great deal less know-how and less efforts. This further reduces cost and time so that building a fixture today takes about 300 to 800 Euro. We have calculated that this fixturing system is profitable after only three fixtures. The costs for any further fixture will only be a fraction of the usual costs. Normally, you will only have 1/5 or 1/8 of the usual costs. What cannot be given in a sum of money is the spontaneity that results from the fact that you are able to build fixtures all on your own – within hours at your own site and without contacting suppliers.

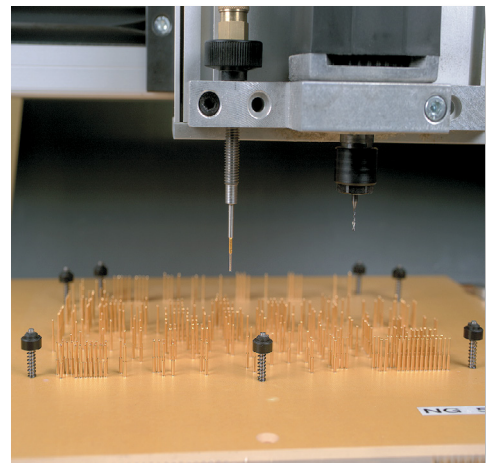
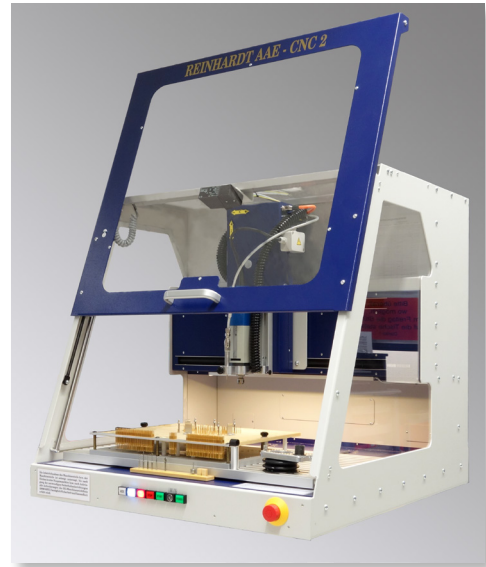

## Our Fixturing System

As Germany's leading manufacturer of In-circuit- and Functional test systems, we have been producing test fixtures for testing electronic PCBs since 1990. Meanwhile, there are more than 86,000 fixturings are used with REINHARDT-fixtures. As we keep close contact with our customers, we know their difficulties in building

In both In-circuit- and Function test you have to measure into the test item, i.e. for location of defect each component has to be contacted or in function test the respective monitoring points or clusters have to be contacted. Spring contact pins are put onto the GRP-plate and make contact with the test item. For that, the test pads are contacted as are solder joints which are used in through-hole technique. For contacting every joint, quite a number of those spring contact pins is

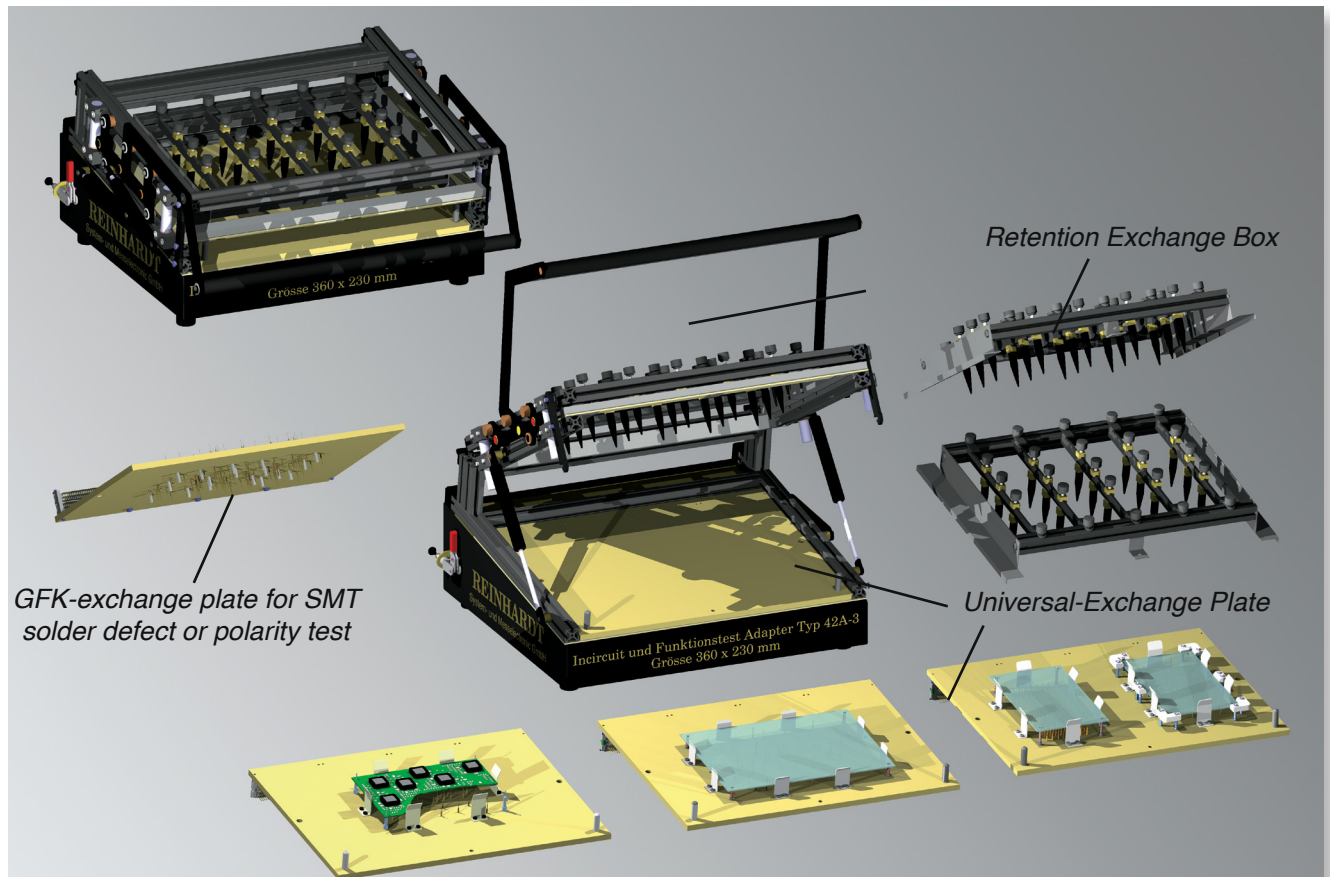

fixtures for in-circuit and functional test. Our long-time experience becomes part of our fixturing systems which are continuously adapted to the requested needs. At the same time, we keep our fixtures practice-oriented and cost-effective.

In the field these systems turned out to stand many millions of contactings of test items. This is granted by a well dimensioned mechanics. Precision deep groove ball bearings are used at the heavily loaded pivot points so that our fixtures are almost maintenance-free.

Ergonomic operation is most important for us. This is why the lids of our test fixtures open wide. In this way, the device under test can be placed and removed quickly and comfortably. Therefore, handling times are short and the operator gets less tired.

put onto the hardboard or GRP-plate. The test item is placed on them and adjusted with collector pins. With retention pins which should be evenly distributed over the PCB, it is pressed to the contacting areas.

### Bed of nails

Our beds of nails (exchange plate) are drawers. Needless to say, the lower GRP-exchange plate (drawer) is compatible to former fixture types. The basic fixture is connected by plugging a number of 64/96way multi-way connectors (only once!). This is why the times for changing component types are very short (typically 1 minute). For technical details, please see the survey of fixture types.



### Retention box

An exchangeable box with retention pins comes with the basic version of a fixture. The retention pins can be adjusted as required by the resp. item to be tested. You therefore only buy the box once – this reduces your testing cost.

For SMT-solder defect test or polarity test you can change the box for an optional upper GRP-exchange plate.

### Working method of an exchange plate fixture

Procedure from placing the test item to contacting it:

1. After opening the upper lid with its integrated retention pins, the test item can be placed comfortably as it is guided precisely by the collector pins.

2. The lower bed of nails is fixed with these types of fixtures. After the upper part with the retention box is turned down, the retention box clicks into place and is then lowered from above – absolutely in parallel with a few hundredth millimeters accuracy at each of the four sides and without any tilting (There are four linear guidings with bronze bushes which do not require maintenance). With its retention pins, the retention box holds down the test item and presses it to the bed of nails with the spring-suspended contact pins. As the front lever is wide and ergonomic, both left-handers and right-handers can use the fixture without difficulties. Operation forces have been distributed so that over 90% of the operational distance, you only apply less than 1 kg force. Only for a peak of a few percent of the total operational distance, the force rises to 6 kg with the maximum number of pins (e. ge. >800).

### Contacting from top and bottom

For contacting from top and bottom, an upper SMT-GRP exchange plate with the pins, polarity test probes and receptacles of spring-suspended reference pins can be used instead of the retention box. Contacting the electronic PCBs from both sides (above and below) is only possible, because REINHARDT-fixtures press down the test item exactly in parallel.

REINHARDT-fixtures offer another big advantage for preparatory measurements for new test programs: Since you always have to measure signals at the single pins, the fixture types 40, 42 and 82C, be it pneumatic or manual, can be opened although the upper part is closed for contacting the test item (see picture below) and you can reach the pin connection for measurement tasks.

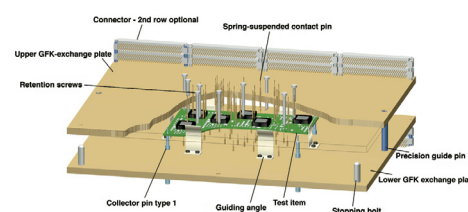
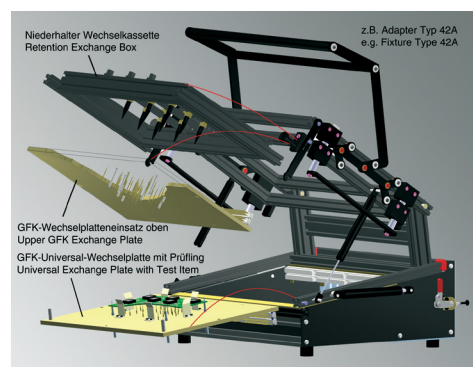

Type 42 with open lower part

## Our Fixtures

### Type 40 Pneumatic Fixture makes contact from both sides

Fixture Type 40 is closed manually, but two pneumatic cylinders press it down. Dual-stage is available so that very precise testing of components is possible. After the test, the pneumatic cylinder returns to its home position and the fixture opens automatically.

Security switch by two-handed operation

Shift: In-circuit test: 20 mm, Function test 13 mm

Compressed air, unoiled, 6 bar, 5 Micron

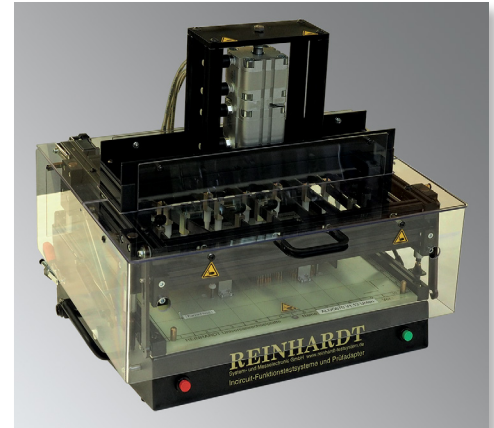

*Type 40B Pneumatic Fixture with Protective Cover*

### Type 42 Manual Fixture allows double-sided contacting

Manual fixture Type 42 is our best-selling fixture. It comes as a desk-version with sloping working area and a lower exchange plate and a retention box. Working area: 360x230 mm, max. 1,000 contact pins



*Type 42A*

### Type 42C Manual Fixture

Fixture Type 42C comes with a sloping working area and is designed for use with an ATS-KMFT 670/ATS-MFT 770 with expansion rack. The fixture has 4 linear guidings. It comes with a lower exchange plate and a retention box and 1 (max. 36) 64- and 7 96-way interchange connectors. Working area: 360x230 mm, max. 1,000 contact pins



*Type 42C*



### Type 82C Manual Fixture

This manual test fixture has a working area of 480 x 320 mm and was designed for a basic system with expansion rack.



*Type 82C Manual Fixture*

### Type 82B Manual Fixture

This manual test fixture has got 480x320mm working area. A lot of space is available inside. This fixture comes with one SR18VG-interface.



*Type 82B*

### Type 127 Manual Fixture

Type 127 was designed for medium-sized PCBs and max. 500 spring contact pins. It is particularly suitable for use with an ATS-UKMFT 627. Fixture Type 127 is delivered with a retention box and retention pins.



*Type 127 Manual Fixture*

### Type 147 Manual Fixture

Fixture Type 147 has the same usable area as types 42 and 40 although its pressure force is for max. 800 spring contact pins. It is also particularly suitable for use with an ATS-UKMFT 627. Type 147 comes with a retention exchange box. With knurled head screws, the 5 longitudinal arms with the retention pins are individually adjusted for the various test items.

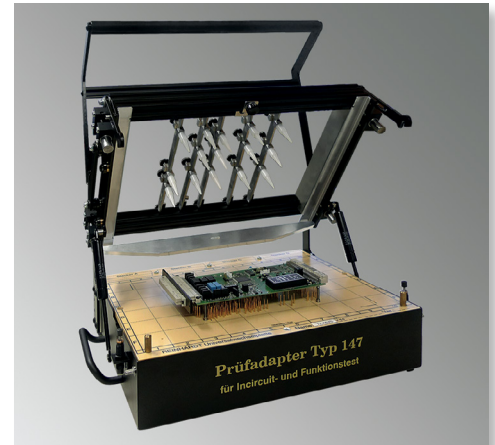

Type 147 Manual Fixture

### Type UJ20 Universally Adjustable Test Fixture

With the universally adjustable test fixture Type UJ 20 single electronic PCBs or smallest series in the development of electronic PCBs can be contacted in a cost-effective way in testing prototypes, in function test of batches or in flashing.

Test fixture Type UJ 20 is equipped with adjustable guiding edges, guiding brinks and guiding pins so that the device under test is repeatedly and exactly positioned. The spring contact pins are positioned so that with the upper hatch they press down on the electronic PCB with its contacting points. The spring contact pins are mounted to jibs which can be aligned in every horizontal position and which are fixed in place with a knurled screw. Via cables, the spring contact pins are connected to an interface connector which itself is connected to the test equipment.

Basic version: 10 contacting jibs 120mm, 1 guiding edge –firmly mounted, 3 guiding edges, 2 guiding brinks, 4 guiding pins.

Interface connector: D-Sub 25 pin unwired

Overall dimensions: W/D/H: about 360 mm/380 mm/200 mm

Board dimensions: max. 270 x 120 mm

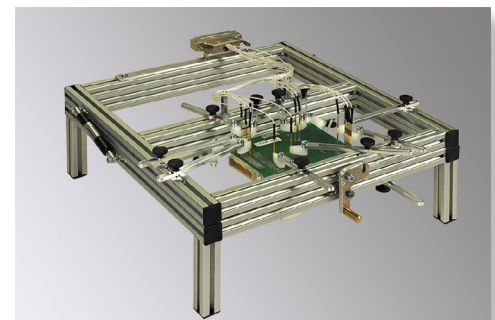

Type UJ 20

### Tandem Module

Tandem module 627/127 is a twin fixture box for contacting 2 fixtures Type 127 on one REINHARDT-test system. The module is designed for mutual contacting for higher throughput. A connection kit for two fixtures Type 127 is included.

Depth about 165 mm, width about 600 mm

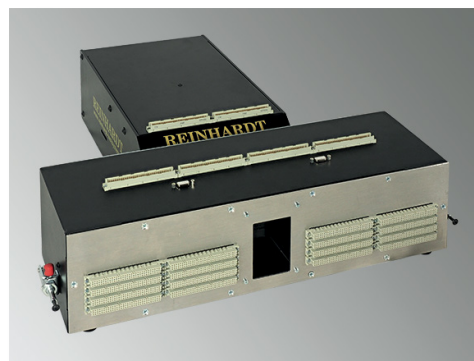

*Tandem Module 627/127*

### Universal Interface Box 165

This box was developed especially for REINHARDT-test systems and allows the easy contacting of function test components with e.g. cable endings and connectors for final functional test. On the one side, there is the SR18VG REINHARDT-interface and on the opposite side there is an aluminium plate, where you can mount connections specifically for the test item. Inside the box (around 10 cm or 16.5 cm deep) the ranging from test system connectors to test item connectors are wired. This avoids a confusing jumble of cables and connectors and resulting operating errors. This interface box also allows to convert the interfaces of other test system producers to REINHARDT-test systems.

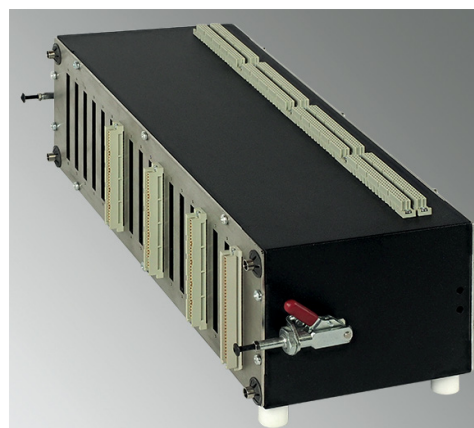

*Universal interface box 165 – similar to picture*

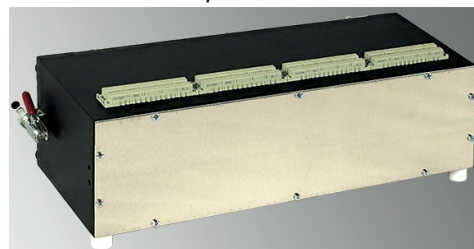

### Converter- and Ranging Box

The Converter- and Ranging Box enables you to connect former REINHARDT-fixture systems to the present 770/670-series. It is plugged between test system and fixture.

### In-line-System



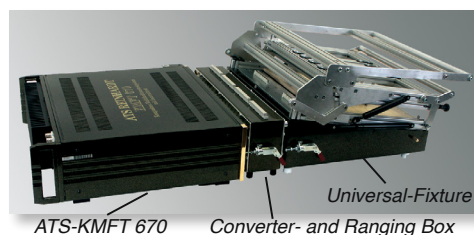



REINHARDT-test systems are designed for both in-line systems and isolated use. Many control options are standard, others are options, such as e.g. the [SteuerMod-Inline USB](#) control module. Via ASCII- or ODBC-interface it can communicate with MES- or process control systems.



*ATS-KMFT 670*

*Universal-Fixture*  
*Converter- and Ranging Box*



More spare parts and accessories for our fixtures are described in a special brochure. Please ask for "Accessories and Spare Parts for REINHARDT-Test Fixtures" or see our homepage on the internet under [http://www.reinhardt-testsystem.de/english/test\\_fixtures/fixture\\_accessories.php](http://www.reinhardt-testsystem.de/english/test_fixtures/fixture_accessories.php).

Fixture-Type	Type 40A	Type 42A	Type 42C	Type 82C	Type 82B	Type 127	Type 147
							
for Function Test for In-circuit Test	✓ ✓	✓ ✓	✓ ✓	✓ ✓	✓ ✓	✓ ✓	✓ ✓
Contacting from Above and Below	✓	✓	✓	✓	✓	✓	✓
Work. Area in mm Width – Depth	360x230	360x230	360x230	480x320	480x320	191.5x172	360x230
Exchange Plates Dimensions in mm	380x297	380x297	380x297	500x400	500x400	217.6x230	380x297
Contact Pins Number	1000	1000	1000	1000**	1000**	500 pcs.	800 pcs.
Operation Force manual Ø in kg	0 kg	2.0 kg	2.0 kg	2.0 kg	2.0 kg	1.9 kg	1.9 kg
Interface Basic Allocation	4x64 total 256	4x64 total 256	1x64, 7x96 total 736	2x64, 3x96 total 416	2x64, 3x96 total 416	2x64 total 128	4x96 pcs. total 384
Interface max. Contacts	SR18VG 1152 (1728*)	SR18VG 1152 (1728*)	SR18VG 1152 (3456*)	SR18VG 1152 (3456*)	SR18VG 1152 (3456*)	SR08VG 512 (768*)	SR08VG 512 (768*)
Exchange Plate Interface Basic Allocation	4x64 total 256	4x64 total 256	4x64 total 256	4x64 total 256	4x64 total 256	2x96 pcs. total 192	4x96 pcs. total 384
Exchange Plate Interface max. Contacts	16x64/96 total 1536	16x64/96 total 1536	16x64/96 total 1536	16x64/96 total 1536	16x64/96 total 1536	8x64/96 total 768	8x64/96 pcs. total 768
Opening and Access when Contacted	✓	✓	✓	✓	✓	–	–
SMT Solder Defect + Polarity Probe	✓/ both sides	✓/ both sides	✓/ both sides	✓/ both sides	✓/ both sides	✓/ both sides	✓/ both sides
Retention Pins/ Arms	15 5	15 5	15 5	18 6	18 6	12 pcs. 4 pcs.	15 pcs. 5 pcs.
Retention Exchange Box	✓	✓	✓	✓	✓	✓	✓
2Level Fixturing Pneu- matic	✓ 6 bar	Option manual	Option manual	–	–	–	–
Manual Operation	left/right	left/right	left/right	left/right	left/right	left/right	left/right
max. Com.Height *** contact one side contact both sides	45 mm 15 mm	45 mm 15 mm	45 mm 15 mm	45 mm 15 mm	45 mm 15 mm	no pocket 15 mm	no pocket 15 mm
Total Dimensions width, depth, height	50x47.5x46 cm	51x51x29 cm	51x54x29 cm	65x64x44 cm	65x64x32 cm	28x33x 23 cm	44x42x23 cm
Weight ca.	21 kg	16kg	20kg	25 kg	25 kg	9 kg	12 kg

\* SR8VG and SR18VG are test system-interfaces for REINHARDT-test systems  
if 96-way connectors are used

\*\* with "Fixture/exchange plate brace 453".

\*\*\* can be increased by milling grooves

Fixture–Type	Type 127	Type 147
		
for Function Test for In–circuit Test	✓ ✓	✓ ✓
Contacting from Above and Below	✓	✓
Work. Area in mm Width – Depth	191.5x172	360x230
Exchange Plates Dimensions in mm	217.6x230	380x297
Contact Pins Number	500 pcs.	800 pcs.
Operation Force manual Ø in kg	1.9 kg	1.9 kg
Interface Basic Allocation	2x64 total 128	4x96 pcs. total 384
Interface max. Contacts	SR08VG 512 (768*)	SR08VG 512 (768*)
Exchange Plate Interface Basic Allocation	2x96 pcs. total 192	4x96 pcs. total 384
Exchange Plate Interface max. Contacts	8x64/96 total 768	8x64/96 pcs. total 768
Opening and Access when Contacted	–	–
SMT Solder Defect + Polarity Probe	✓/ both sides	✓/ both sides
Retention Pins/ Profile Arms	12 pcs. 4 pcs.	15 pcs. 5 pcs.
Retention Exchange Box	✓	✓
2Level Fixturing Pneu- matic	–	–
Manual Operation	left/right	left/right
max. Comp. Height** contact one side contact both sides	no pocket 15 mm	no pocket 15 mm
Total Dimensions width, depth, height	28x33x 23 cm	44x42x23 cm
Weight ca.	9 kg	12 kg



**Sources and Loads**

4x 38 V, 1 mV  
2 A/1 A, 50  $\mu$ A

6x  $\pm$ 40 V,  $\pm$ 5 V  
 $\pm$ 15 V,  $\pm$ 5 V

Fr. 1 MHz  
25 Veff, 1 mV

Electronic Load  
0-5.1 A

**DEC 670**  
Multifunction

2 RS 232 300 Hz-  
1.25 MHz

2  $\Gamma$ C 56 kHz-  
1.0 MHz

1 USB 500 mA  
480 MHz

1 SPI 1.8-5 V  
to 10 MHz

Pulsigen 0.8 s-50 ns  
to 10 MHz

1 RS 485 300 Hz-  
1.25 MHz

3 X RL 2 A 60 W  
100 V

2 x 8 SPS 16 Bit  
1.8-5 V

**Meas. Unit**  
ICT-Function

ICT Meas. Unit

DC AC Peak

DC-AC Meas. Unit

Time-Frequency Meas. Unit

Transient recorder

**MMX 670**  
Stimul. matrix

48 channels in 12 busses 2 A  
expandable to 384 channels

2 4Quadrant PSUs  
0 to +38 V  
0 to -38 V  
max. 500 mA  
resolution  
U 1 mV  
I 10  $\mu$ A

**RMX 96**  
Meas. Matrix

3Wire techn.  
expandable to 1,440 (4,320)  
In-circuit- and function test channels  
max. 0.5 A,  
100 V, 10 VA

**Monitoring**

Monitoring for stimulus sources

**VMX 8**  
Meas. Matrix

8 Meas. chan.  
420 V  
0-400 Hz  
with pre-scaler and buffer amplifier

**LOG 670**  
Logic Board

32 bi-directional channels  
expandable to 256 channels  
logic board 0-30 V  
prog. 10 mV

**LOG 96**  
Logic Board

96 bi-directional channels  
expandable to 256 channels  
logic board for 3.3 V / 5 V

**RML32 Meas. Logic-Stim.**

32 Meas. chan.

24 channels stimulus matrix 2 A

32 Logic channels



- In-circuit-/Function test software
- Graphic display of fault location
- Software for processing Gerber files
- Quality management – statistics software
- ODBC-Interface
- CAD-Interface
- Boundary Scan
- ODT Optical Display Test
- Fieldbus, CAN, Profi, LAN, GPIB...
- Function arbitrary generator
- Power electronics
- Fixture production system
- Test fixtures and modules

Legend: ● : Standard, ○ : Option

**MMX 72**  
Stimulus Matrix

72 channels in 18 busses 2 A  
expandable to 576 channels

**EMX 48**  
Stimulus Matrix

48 normally open contacts, 230 V, 2 A  
expandable to 384 channels

**NGS 3Fold**  
PSUs

0-8 V, 0-4 A  
Programmable  
2 mV 1 mA

0-38 V, 0-1 A  
Programmable  
10 mV 0.25 mA

0-38 V, 0-1 A  
Programmable  
10 mV 0.25 mA

**PML 670**  
Pre-Logic Board

16 channels can be programmed individually  
0-30 V  
resol. 500  $\mu$ V  
for driver and comparator  
max. 50 mA

**TRA 670**  
Transient Recorder

Transient recorder  
50 MHz  
sample rate  
250 MHz  
8 HF 50  $\Omega$   
9 1 M $\Omega$  chan.  
res. 250  $\mu$ V  
all means.  
channels can be evaluated  
auto. envelope curve

**AC 670**  
AC/DC-Source

AC-source, frequency variable  
35 Hz-6.5 kHz  
0.1 Hz-steps  
quartz exact  
0 to 280 V  
40 W, 12 bit resolution

DC-source  
0-350 V  
0-100 mA  
res. voltage  
current 12 bit

**LMX 670-8**  
Power Matrix

420 V, 20 A,  
4000 VA  
8 meas. channels  
420 V  
0-400 Hz  
with pre-scaler and buffer amplifier

**Motor Trimmer R-Decade**

Mechanical adjustment of potentiometers  
"0"-adjustment max./min./des. value, right/left stop

Resistances 1 to 16.7 M $\Omega$   
in 1  $\Omega$ -steps + E-series



**HSM 670**  
HV Stim. Matrix

16 channels  
250 V  
AC-DC  
10 A  
expandable to 64 channels

**PMX 16**  
Power Matrix

16 channels  
100 VDC  
70 V ACeff  
max. 4 channels with 10 A parallel  
1,000 W switch. power, max.  
64 channels

**Sources and Loads**

- 4x  38 V, 1 mV  
2 A/1 A, 50  $\mu$ A
- 6x   $\pm$ 40 V,  
 $\pm$ 15 V,  $\pm$ 5 V
- Fr. 1 MHz  
25 Veff, 1 mV
- Electronic Load  
0–5.1 A

**DEC 670**  
Multifunction

- 2 RS 232 300 Hz–1.25 MHz
- 2 I<sup>2</sup>C 56 kHz–1.0 MHz
- 1 USB 500 mA–480 MHz
- 1 SPI 1.8–5 V to 10 MHz
- PulsGen. 0.8 s–50 ns to 10 MHz
- 1 RS 485 300 Hz–1.25 MHz
- 3 X RL 2 A 60 W 100 V
- 2 8 SPS 16 Bit 1.8–5 V

**Meas. Unit ICT-Function**

- ICT 

**ICT Meas. Unit**

- DC AC Peak

**DC-AC Meas. Unit**

- Prog. Rise-Fall

**Time-Frequency Meas. Unit**

- Transient recorder



**MMX 670**  
Stimul. matrix

- 48 channels in 12 busses 2 A expandable to 384 channels
- 2 4Quadrant PSUs 0 to +38 V 0 to -38 V max. 500 mA resolution U 1 mV I 10  $\mu$ A

**RMX 96**  
Meas. Matrix



- 3Wire techn. expandable to 1,152 (3,840) In-circuit- and function test channels max. 0.5 A, 100 V, 10 VA

**Monitoring**

- IMON 
- 32
- IMON 



Monitoring for stimulus sources

**VMX 8**  
Meas. Matrix

- HVMX 
- 8
- HVMX 



8 Meas. chan. 0–400 Hz with pre-scaler and buffer amplifier

**LOG 670**  
Logic Board

- LOG 
- 32
- LOG 

32 bi-directional channels expandable to 256 channels logic board 0–30 V prog. 10 mV

**LOG 96**  
Logic Board

- LOG 
- 96
- LOG 

96 bi-directional channels expandable to 256 channels logic board for 3.3 V / 5 V

**RML32 Meas. Logic-Stim.**



- RMX 
- 32 Meas. chan.
- MMX 
- 24 channels stimulus matrix 2 A
- LOG 
- 32 Logic channels 3.3V–5V

- In-circuit-/Function test software
- Graphic display of fault location
- Software for processing Gerber files
- Quality management – statistics software
- ODBC-Interface
- CAD-Interface
- Boundary Scan

- ODT Optical Display Test
- Fieldbus, CAN, Profi, LAN, GPIB...
- Function arbitrary generator
- Power electronics
- Fixture production system
- Test fixtures and modules



Legend: ● : Standard, ○ : Option

**MMX 72**  
Stimulus Matrix

- MMX 
- 72
- MMX 

72 channels in 18 busses 2 A expandable to 576 channels

**EMX 48**  
Stimulus Matrix



- EMX 
- 48
- EMX 

48 normally open contacts, 230 V, 2 A expandable to 384 channels

**NGS 3Fold**  
PSUs

- 0–8 V, 0–4 A Programmable 2 mV 1 mA
- 0–38 V, 0–1 A Programmable 10 mV 0.25 mA
- 0–38 V, 0–1 A Programmable 10 mV 0.25 mA

**PML 670**  
Pre.Logic Board

- Pre-LOG 
- 16
- Pre-LOG 

16 channels can be programmed individually 0–30 V resol. 500  $\mu$ V for driver and comparator max. 50 mA



**TRA 670**  
Transient Recorder

- Transient recorder
- 50 MHz sample rate
- 250 MHz 8 HF 50  $\Omega$  channels
- 9 1 M $\Omega$  chan. res. 250  $\mu$ V all meas. channels can be evaluated auto. envelope curve

**AC 670**  
AC/DC-Source

- AC-source, frequency variable
- 35 Hz–6.5 kHz 0.1 Hz-steps quartz exact 0 to 280 V
- 40 W, 12 bit resolution
- DC-source 0–350 V 0–100 mA res. voltage current 12 bit

**LMX 670-8**  
Power Matrix



- LMX B 
- 8
- LMX B 

420 V, 20 A, 4000 VA 8 meas. channels 420 V 0–400 Hz with pre-scaler and buffer amplifier

**Motor Trimmer R-Decade**



- Motor-schraubstopf 
- Mechanical adjustment of potentiometers "0"-adjustment max./min./des. value, right/left stop
- Resistances 1 to 16.7 M $\Omega$  in 1  $\Omega$ -steps + E-series

**HSM 670**  
HV Stim. Matrix

- HVMX 
- 16
- HVMX 

16 channels 250 V AC-DC 10 A expandable to 64 channels

**PMX 16**  
Power Matrix

- Channel 1 
- 16
- Channel 16 

16 channels 100 VDC 70 V ACeff max. 4 channels with 10 A parallel 1,000 W switch. power, max. 64 channels